

 **BOSS**

RPD-10

DIGITAL

PANNING DELAY

INSTRUCTIONS

Please read the instructions carefully.

FEATURES

The BOSS RPD-10 is a completely new type machine that can create a panning delay effect which was only possible by using two delay machines.

- This unit can create as long as two second delay time. → The best possible panning effect can be obtained.
- This unit features Chorus mode. → It can be used as a stereo chorus effect.
- The Direct Cancel Switch is provided. → The unit can send only effect sounds to a mixer.
- This unit features the Input Level Selector Switch and both a standard phone jack and a pin jack for input. → Not only a musical instrument but also audio equipment can be used with this unit.
- Using the optional adaptor RAD-10, this unit can be mounted on a standard 19" rack (EIA).

CONTENTS

1	Panel Description	3
2	Connection	6
3	Operation	7
4	Setting Samples	8
5	Setting Memo	9
6	Important Notes	10
7	Specifications	11

RADIO AND TELEVISION INTERFERENCE

Warning - This equipment has been verified to comply with the limits for a Class B computing device, pursuant to Subpart J, of Part 15, of FCC rules. Operation with non-certified or non-verified equipment is likely to result in interference to radio and TV reception.

The equipment described in this manual generates and uses radio-frequency energy. If it is not installed and used properly, that is, in strict accordance with our instructions, it may cause interference with radio and television reception.

This equipment has been tested and found to comply with the limits for a Class B computing device in accordance with the specifications in Subpart J, of Part 15, of FCC Rules. These rules are designed to provide reasonable protection against such a interference in a residential installation.

However, there is no guarantee that the interference will not occur in a particular installation. If this equipment does cause interference to radio or television reception, which can be determined by turning the equipment on and off, the user is encouraged to try to correct the interference by the following measure:

- Disconnect other devices and their input/output cables one at a time. If the interference stops, it is caused by either the other device or its I/O cable.

These devices usually require Roland designated shielded I/O cables. For Roland devices, you can obtain the proper shielded cable from your dealer. For non Roland devices, contact the manufacturer or dealer for assistance.

If your equipment does cause interference to radio or television reception, you can try to correct the interference by using one or more of the following measures:

- Turn the TV or radio antenna until the interference stops.
- Move the equipment to one side or the other of the TV or radio.
- Move the equipment farther away from the TV or radio.
- Plug the equipment into an outlet that is on a different circuit than the TV or radio. (That is, make certain the equipment and the radio or television set are on circuits controlled by different circuit breakers or fuses.)
- Consider installing a rooftop television antenna with coaxial cable lead-in between the antenna and TV.

If necessary, you should consult your dealer or an experienced radio/television technician for additional suggestions. You may find helpful the following booklet prepared by the Federal Communications Commission:

"How to Identify and Resolve Radio-TV Interference Problems"
This booklet is available from the U.S. Government Printing Office, Washington, D.C. 20402, Stock No. 004 000-00345-4.

Bescheinigung des Herstellers/Importeurs

Hiermit wird bescheinigt, daß der/die/das

- **BOSS DIGITAL PANNING DELAY RPD-10**

(Gerät Typ Bezeichnung)

in Übereinstimmung mit den Bestimmungen der

Amtsbl. Vfg 1046 / 1984

(Amtsblattverfügung)

funk-enstort ist.

Der Deutschen Bundespost wurde das Inverkehrbringen dieses Gerätes angezeigt und die Berechtigung zur Überprüfung der Serie auf Einhaltung der Bestimmungen eingeräumt.

Roland Corporation Osaka/Japan

Name des Herstellers/Importeurs

1 PANEL DESCRIPTION

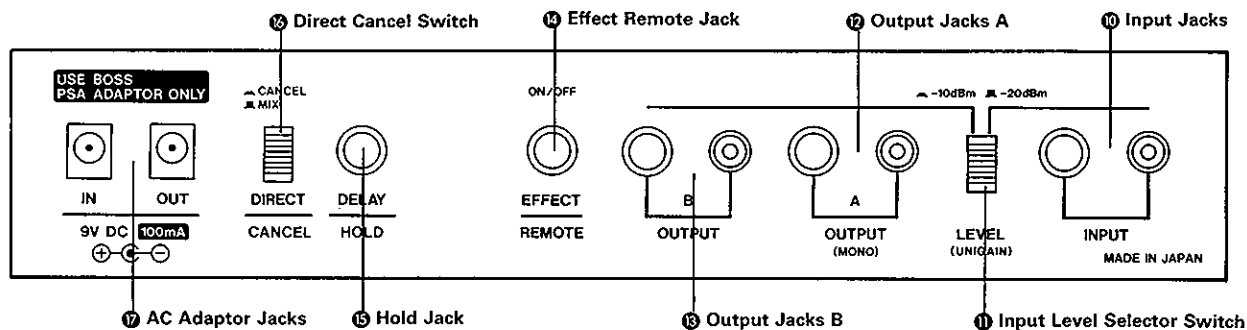
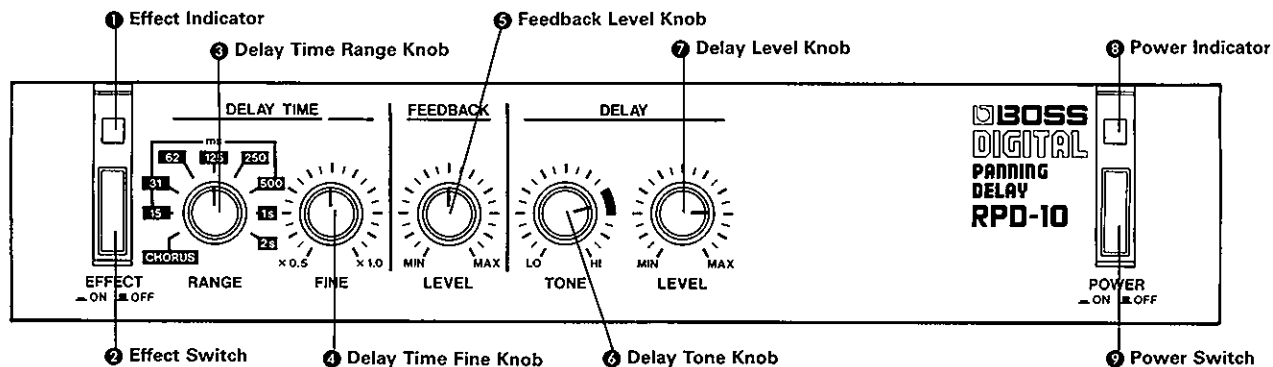

① Effect Indicator

This lights up when the effect is turned on.

② Effect Switch

This turns on or off the effect.

③ Delay Time Range Knob

This selects one of the 8 delay time ranges (15ms to 2s).

* When you change delay time range from "2s" to any other one or from any range to "2s", muting circuits are activated, therefore no delay sound is heard for a few seconds.

When "CHORUS" position is selected, the unit is turned to Chorus mode, behaving like a stereo chorus.

④ Delay Time Fine Knob

This knob can finely adjust the delay time range set with the Delay Time Range Knob. The set delay time can be continuously changed from "×0.5" to "×1".

* Using the Delay Time Range Knob and the Delay Time Fine Knob, delay time can be set from 7.5 ms to 2s continuously.

When the Chorus mode is selected, this knob adjusts the depth of the chorus effect.

⑤ Feedback Level Knob

This sets the number of the delay repeats. Clockwise rotation increases the number of the repeats, and at its fully counterclockwise position, a single delay (one delay for each right and left each in stereo) will be created.

* When this knob is set fully clockwise, oscillation may occur. If so, rotate the knob counterclockwise until the oscillation stops.

* This knob does not work in the Chorus mode.

⑥ Delay Tone Knob

This adjusts the tone of the delay (or chorus) sound. Rotating the knob counterclockwise cuts higher frequencies, creating softer sound. At 3 o'clock position, almost flat characteristic is obtained.

⑦ Delay Level Knob

This controls the volume of the delay (or chorus) sound. Clockwise rotation raises the volume.

⑧ Power Indicator

This lights up when the unit is turned on.

⑨ Power Switch

⑩ Input Jack

Connect a musical instrument or audio equipment to this jack.

* The standard and the pin jacks cannot be used at the same time. When both are used simultaneously, the standard phone jack will work.

⑪ Input Level Selector Switch

Set this switch depending on the output level of the connected device.

* When a musical instrument is connected, set the switch to "-20dBm", and when an AV equipment is connected, set it to "-10dBm". When sounds are distorted at "-20dBm" position, set it to "-10dBm".

* Changing this switch does not affect the volume of the sound.

12 Output Jacks A

Connect this jack to a device such as guitar amplifier, stereo amplifier or tape deck. (Both the standard and pin jacks can be simultaneously used.)

* Use this jack for monaural use.

13 Output Jacks B

By using this jack together with the Output Jack A in stereo, panning effect can be obtained. (Both the standard and pin jacks can be simultaneously used.)

14 Effect Remote Jack

By connecting a footswitch FS-5L (optional) to this jack, Normal/Effect mode can be selected using the pedal.

* Make sure that the Effect Switch on the panel is turned on.

When using two sets of the BOSS Micro Studio Series, it may be a good idea to connect the Effect Remote Jack of one unit to another one, so that you can turn on or off the effects of both units simultaneously by operating one unit.

15 Hold Jack

This jack is to connect the FS-5U (optional footswitch). As long as the footswitch is depressed, the input sound will be repeated.

* The Hold effect cannot be obtained when the unit is in the normal mode (=effect is off)

16 Direct Cancel Switch

When this switch is turned on, direct sound is cut, only the delay (or chorus) sound being sent out. This is useful for effect-loop use of a mixer.

17 AC Adaptor Jacks

The "IN" jack is to connect the AC adaptor (BOSS PSA-120, 220 or 240) or the Power Supply (BOSS RPW-7). Connect the plug of the AC adaptor or the Power Supply to "IN". To supply power to other BOSS Micro Studio Series, connect the supplied DC cord to "OUT".

* When using the PSA-Adaptor, be sure the total current draw does not exceed 200mA, and when using the RPW-7, 700mA. (The current draw of each unit is shown on its rear panel.)

2 CONNECTION

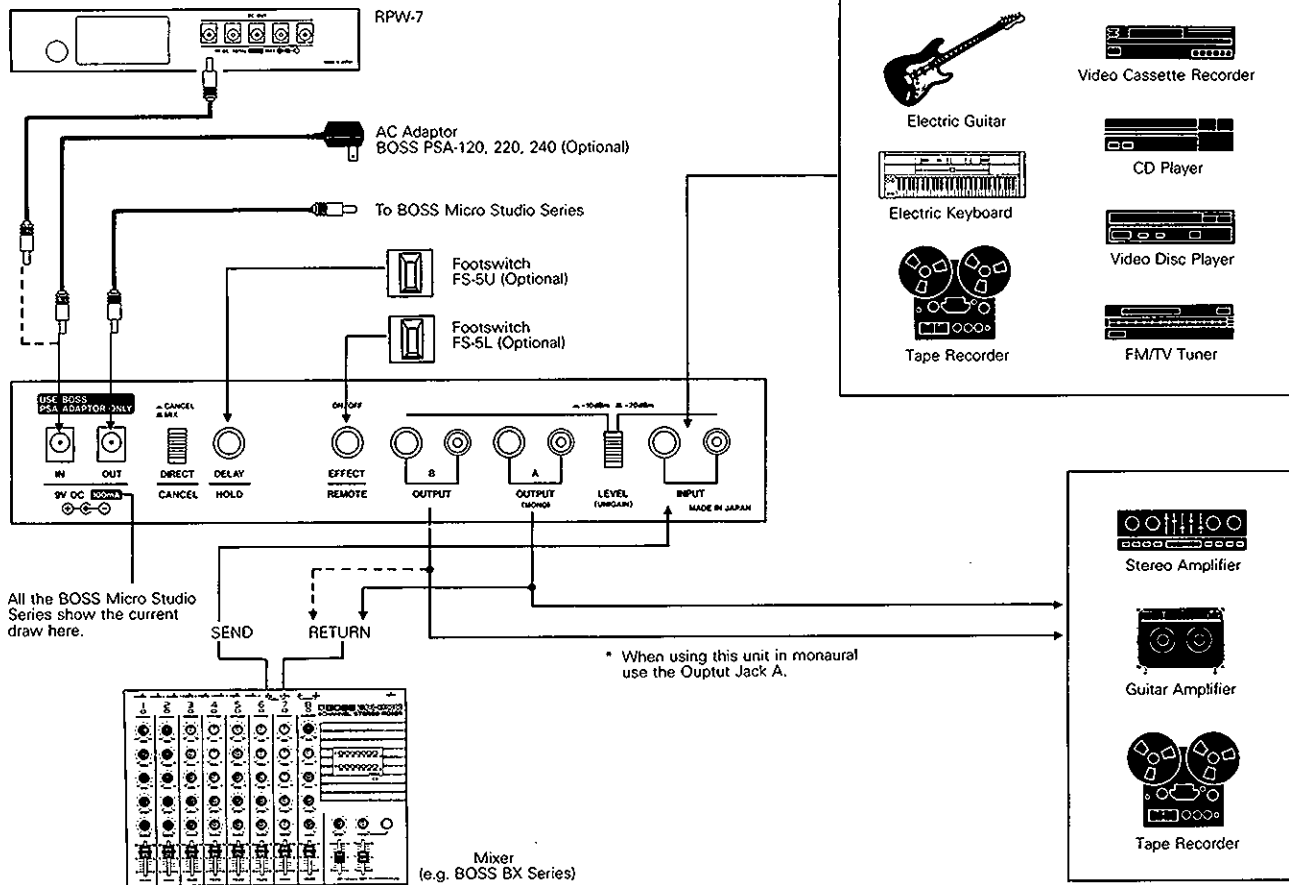

3 OPERATION

- ① Set the controls on the panel as shown below.

Using the unit as a delay machine

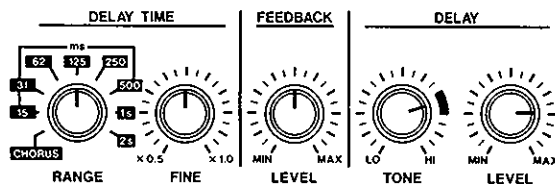

Using the unit as a chorus machine

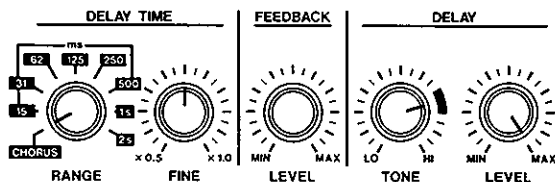

Set the Effect Switch to the OFF position.
Set the Direct Cancel Switch on the rear panel to the MIX position except when a mixer (effect loop) is used.

- ② Push the Power Switch and make sure the Power Indicator lights up.

- ③ Set the Input Level Selector Switch to either position depending on the output level of the device.

- ④ Turn the Effect Switch on (the Effect Indicator lights up), and delay (or chorus) effect is obtained.

- ⑤ Using the controls on the panel, make a desired sound. (See page 4.)

- ▷ By connecting an optional footswitch (FS-1, FS-5L etc) to the Effect Remote Jack, the effect can be turned on or off by pressing the pedal.

* Be sure that the Effect Switch on the panel is turned on.

* The RPD-10 can be turned from effect to normal mode without cutting the delay sound currently played.

- ▷ By connecting an optional footswitch (FS-5U etc.) to the Hold Jack, the Hold effect can be obtained as long as the pedal is depressed. The length of each repeat is the delay time currently set.

* The Hold effect cannot be obtained when the unit is in normal mode (=effect is off).

4 SETTING SAMPLES

1) Light Chorus

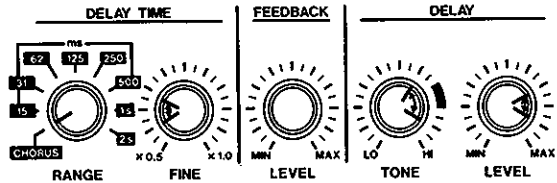

2) Deep Chorus

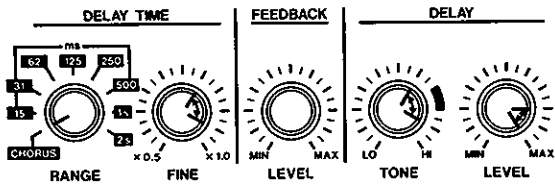

3) Short Delay

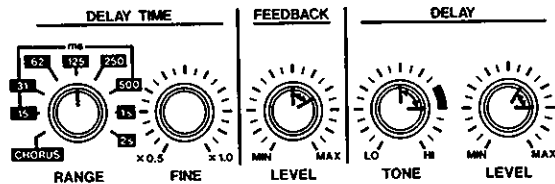

4) Long Delay

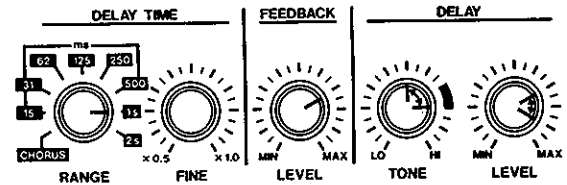

5) Effect as if played by three persons

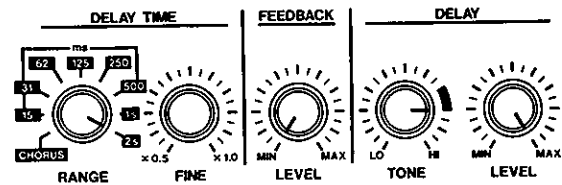

5 SETTING MEMO

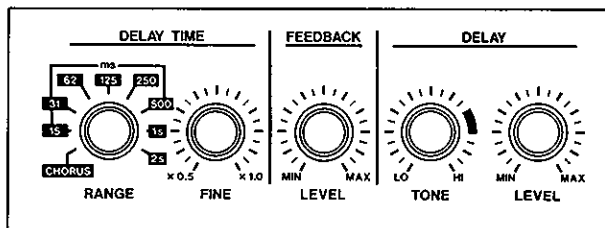
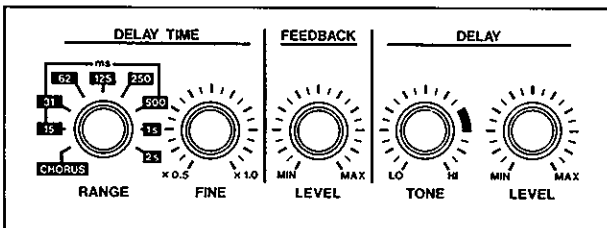
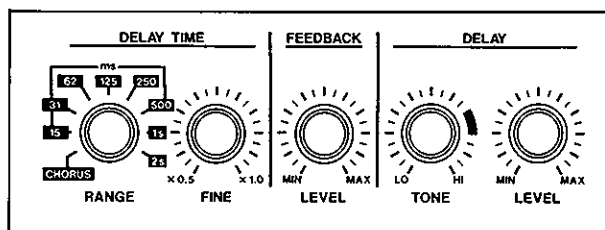
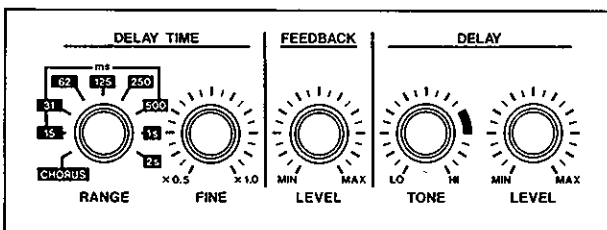
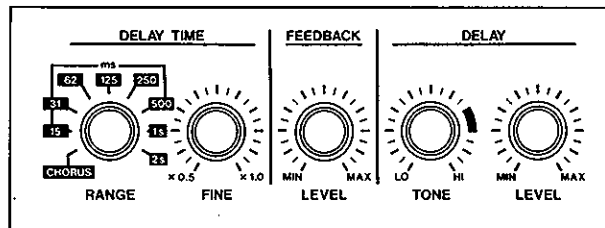
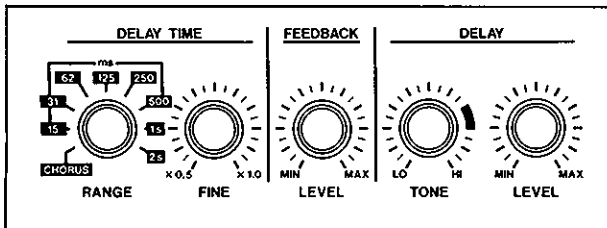

6 IMPORTANT NOTES

- For about 10 seconds after the unit is turned on, it does not function because of the muting circuit.
- When you are using only one AC adaptor (or RPW-7) for supplying power to more than one unit, please be sure that the total current draw does not exceed 200mA (or 700mA).
- When the unit is not to be used, disconnect the AC adaptor from the socket.
- Avoid using the unit in excessive heat or humidity or where it may be affected by dust or vibration.
- Never remove the cabinet from the unit.
- When you use the unit on its own without using the optional Rack Mount Adaptor RAD-10, please attach the rubber feet as shown below.

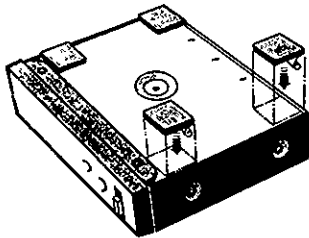

■ AC Adaptor, Power Supply

BOSS PSA-120, 220 or 240 (optional)
BOSS RPW-7 (optional)

Be sure to use the above AC adaptor or power supply. Using any other adaptor or power supply will cause trouble.

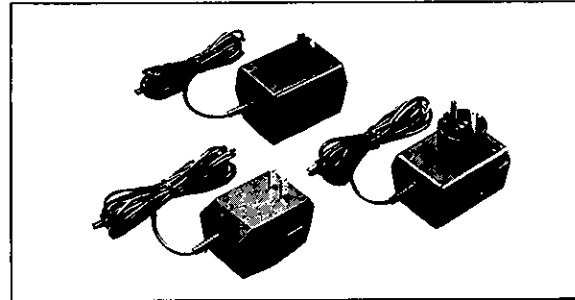

■ Rack Mounting

The RPD-10 is one of the BOSS Micro Studio Series, and any two of the series can be mounted in a standard 19" rack (EIA-1U) by using the optional Rack Mount Adaptor RAD-10.

Remove the rubber feet from the bottom of the units, fix the units on the Rack Mount Adaptor with the supplied screws, then place the whole set on the rack.

7 SPECIFICATIONS

Input Level/Input Impedance:

-20dBm/1M Ω , -10dBm/47k Ω

Output Level/Output Impedance:

-20dBm/2k Ω , -10dBm/2k Ω

Output Load Impedance:

Over 10k Ω

Sampling System:

12 bit quantizing and analog logarithmic compression system (8 bit when the Delay Time Range is set to 2s)

Frequency Response:

Direct : 10Hz to 60kHz ($+1_{-3}$ dB)

Delay : 20Hz to 15kHz ($+1_{-3}$ dB)

Residual Noise:

Below -100dBm (IHF-A) when the Input Level Selector Switch is set to -20dBm

Controls:

Delay Time Range (9 steps)

Delay Time Fine

Feedback Level

Delay Tone

Delay Level

Switches:

Power (ON/OFF)

Effect (ON/OFF)

Input Level Selector (-20dBm/-10dBm)

Direct Cancel (Cancel/Mix)

Indicators:

Power

Effect

Jacks:

Inputs (Standard, Pin)

Outputs A (Standard, Pin)

Outputs B (Standard, Pin)

Effect Remote (ON/OFF)

Hold (ON/OFF)

Power:

9VDC (BOSS PSA-120, 220 or 240, RPW-7)

Current Draw:

100mA

Dimensions:

218(W) \times 169(D) \times 44(H)mm/

8 $\frac{7}{8}$ " \times 6 $\frac{5}{8}$ " \times 1 $\frac{3}{4}$ "

Weight:

900g/2 lb

Accessories:

DC Cord (0.5m)

Rubber Feet \times 4

OPTIONS

AC Adaptor PSA-120, 220 or 240

Power Supply RPW-7

Rack Mount Adaptor RAD-10

Footswitch FS-5L, FS-5U, FS-1 (Roland)

* Specifications are subject to change without notice.

 **BOSS**
Products of Roland