

# JUNO-6

Operation Manual

 Roland

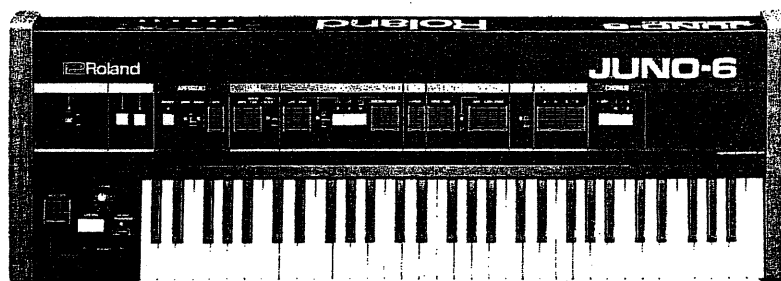

- The Roland Juno-6 is a six voice and sixty-one key polyphonic synthesizer.
- The Digitally controlled Oscillator that offers exceptionally stable pitch.
- The real six voice polyphonic synthesizer completely equipped with 6 VCF's, 6 VCA's and 6 ENV's.
- An Arpeggio function that enables you to enjoy wide variation of the patterns by changing the MODE and the RANGE.
- Chorus effects that expand the sounds for a rich performance.
- A key transpose function that allows you to transpose to any keys.
- ★ It is necessary for you to understand the functions of the controls and selectors of the Juno-6 perfectly so that you can fully enjoy the advantages of the unit. Some setting examples are shown in this manual so that it might be easier for you to master how to operate the Juno-6, but you are the one who creates the sounds. Please find out your own setting and new ways of playing.

## Contents

---

● Basic Connections . . . . .	5	● Arpeggio Samples . . . . .	17
● Functions . . . . .	6	● Sample Sounds . . . . .	18
I. Functions for Sound Creating . . . . .	6	● Sound Synthesis Memo . . . . .	29
DCO . . . . .	6	● Specifications . . . . .	32
HPF . . . . .	8	● Options . . . . .	33
VCF . . . . .	8		
VCA . . . . .	10		
ENV . . . . .	10		
LFO . . . . .	11		
II. Functions for Playing . . . . .	12		
Keyboard . . . . .	12		
Controllers . . . . .	12		
Arpeggio . . . . .	13		
Hold . . . . .	14		
Key Transpose . . . . .	14		
Remote Controls . . . . .	15		
III. Effects . . . . .	16		
Chorus . . . . .	16		
Other Effects (Options) . . . . .	16		

Functions for Playing

Effect

**KEY TRANSPOSE button**  
Hold this button down and press the key to which you want to transpose.

**RANGE switch**  
Changes the pitch ranges.

**HOLD switch**  
The sound remains even after the key is released. (This applies to Arpeggio as well.)

**RATE**  
Changes the speed of Arpeggio.

**POWER switch**

**ON/OFF switch**  
Turns on and off the Arpeggio function.

**MODE switch**  
Changes the movement of the patterns.

**LFO** A Low Frequency Oscillator that generates vibrato and growl effects.

**DCO** Digitally controlled Oscillator that determines the pitch. It also generates three waveforms that are the sound source of the synthesizer.

**HPF & VCF** The filter that cuts or emphasizes harmonics and consequently determines the tone color.

**VCA** The amplifier that controls the amplitude, resulting in changing the volume.

**ENV** It generates the control voltage which is applied to the VCA and VCF, controlling the harmonics and the volume.

**CHORUS mode switch**  
This changes the depth of the Chorus effect.

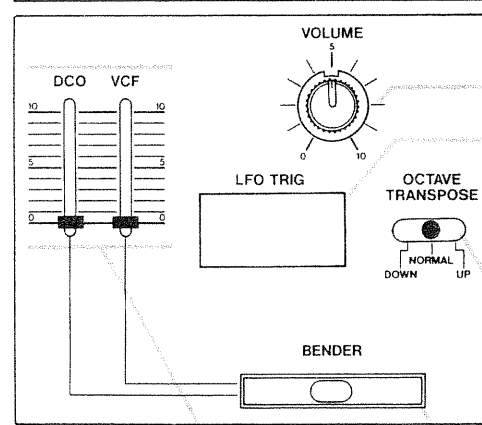
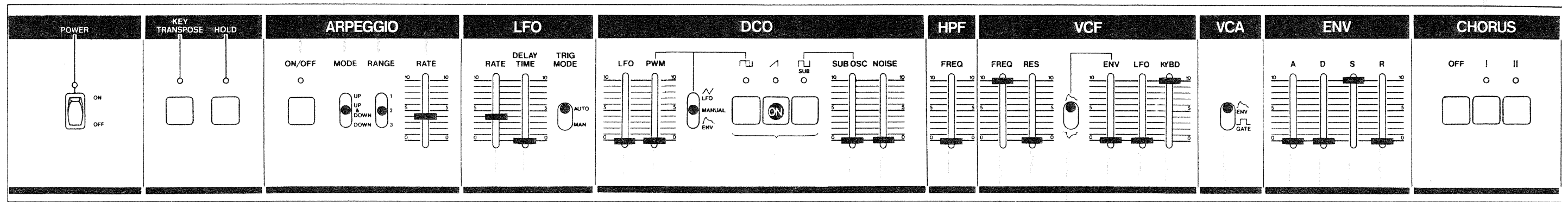

**VOLUME**  
**LFO TRIGGER button**  
The manually operated button for the LFO. (It works when the TRIGGER MODE switch, situated in the LFO, is set to MANUAL.)

**TRANSPOSE**  
To alter the range of the keyboard. (1 octave up and down.)

**BENDER**  
A manually operated lever which controls the pitch of the DCO and the Cutoff Frequency of the VCF.

**Bend sense**  
This control sets the maximum effect of the BENDER.

**RATE**  
This controls the rate of the LFO.

**DELAY TIME (Rise Time)**  
(AUTO) In this mode it delays the vibrato (growl) effects by the set amount. (MANUAL) While the LFO TRIGGER button is being pressed, the DELAY TIME determines the time required for the LFO signal to become maximum.

**TRIGGER MODE switch**  
The LFO operates either manually or automatically depending on which position this switch is set to. (MANUAL, AUTO)

**LFO modulation**  
It adjusts the depth of the vibrato effect.

**Pulse Width Modulation**  
(MANUAL) The pulse width is adjusted. (LFO, ENV) The intensity of the modulation is controlled.

**PWM mode switch**  
To select the pulse width controlling signal.

**Waveform**  
You can select the output waveform of the DCO. (Each of them can be switched on and off individually.)

**SUB OSCILLATOR level**

**NOISE level**  
This is the volume of another sound source, NOISE.

**HPF Cutoff FREQUENCY**  
As you raise the knob, low frequency is cut. (The sound is getting brighter.)

**Cutoff FREQUENCY**  
As you lower the knob, high frequency harmonics are cut off. (The sound is getting softer.)

**RESONANCE**  
This emphasizes the Cutoff Point (creating unusual sounds).

**Polarity switch**  
This determines the polarity of the Envelope. (Negative polarity is for special effect.)

**ENV modulation**  
This adjusts the level of the Envelope signal which controls the Cutoff Point of the VCF.

**LFO modulation**  
This adjusts the depth of the growl/wah effects.

**KEY follow**  
As you lower the Knob, the difference of the tone colors between different notes becomes larger.

**Control signal select switch**  
This selects the signal which controls the VCA. (It decides whether to change the volume by using Envelope signal or Gate signal.)

**ATTACK time**  
This controls the time needed for the voltage to reach its maximum level after the key is pressed.

**DECAY time**  
This determines the time needed for the voltage to reach the Sustain level.

**SUSTAIN level**  
This determines the Sustain level to which the voltage falls at the end of the Decay time.

**RELEASE time**  
This sets the time required for the sound to finally fade out after the key is released.

Functions for Playing

Functions for Sound Creating

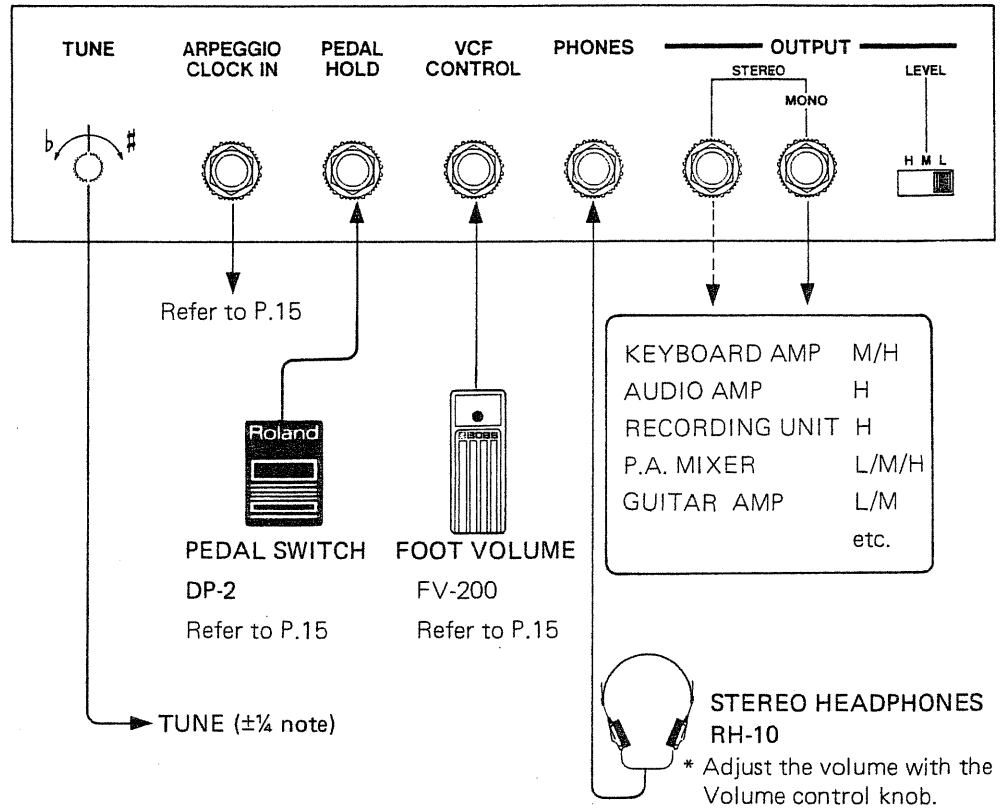



DCO  
(Digitally Controlled Oscillator)

DCO is the digitally controlled oscillator that controls the pitch and creates three types of waveforms which are the sound source of the synthesizer. Compared to VCO (Voltage Controlled Oscillator), DCO has superior stability. The operations and functions of

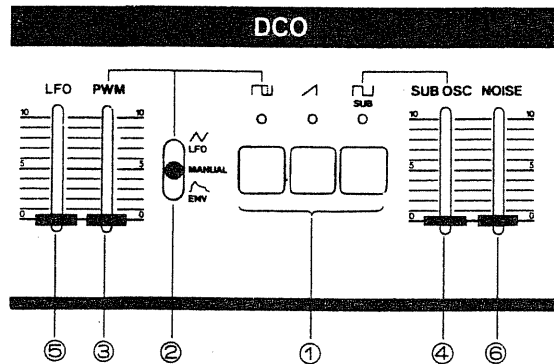
the DCO are virtually the same as those of the VCO. A DCO does not, however, provide portament function, because of its digitally controlled system.



①    • WAVEFORMS

You can select the output Waveform of the DCO. Each switch can be individually turned on and off and can be used with other switches.

<Pulse Wave>

When the top and bottom portions of the square wave are unequal, the result is what is called a pulse wave. The harmonic content of the pulse wave will depend greatly on the width of the pulses. It is possible to modulate, or change the pulse width by means of the LFO or the envelope generator.

② PWM MODE switch

When it is set to (MAN), pulse width can be set with the PWM knob ③. When it is set to LFO or ENV, pulse width is controlled by the corresponding signal from the LFO or the envelope generator.

③ PWM • Pulse Width Modulation

When PWM MODE switch ② is set to (MAN), this knob controls pulse width, and controls the intensity of the modulation when it is set to LFO or ENV.

④ SUB OSC • Sub Oscillator Level

It controls the volume of the SUB OSC.







⑤ LFO • LFO MODULATION

It adjusts the depth of the vibrato effect when the LFO is controlling the pitch of the DCO.

⑥ NOISE • NOISE level

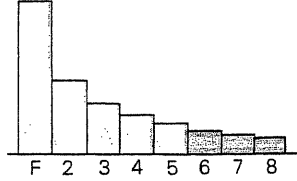
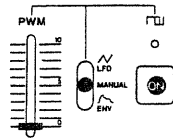
It controls the volume of the NOISE.

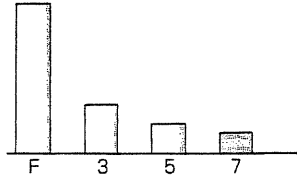
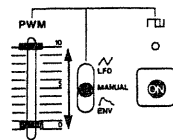
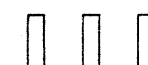
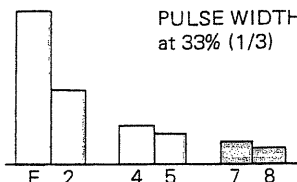
Waveform

Setting	Waveform	Description	Harmonic Content
	 <p>Saw Tooth</p>	<p>The sawtooth wave contains a fundamental sine wave and its integral harmonic sine waves at a fixed ratio. The level of each harmonic is as shown on the right. When fundamental content is 1, the content of <math>n</math>th harmonic is <math>1/n</math>.</p>	
	 <p>Square</p>	<p>The square wave contains a fundamental sine wave and its odd numbered harmonics at a fixed ratio. The level of each harmonic is the same as sawtooth wave: the content of <math>n</math>th harmonic is <math>1/n</math>; except that there are no even numbered harmonics.</p>	
	 <p>Pulse</p>	<p>With pulse wave, the harmonic content greatly varies depending on the pulse width. It is characterized by a lack of the <math>n</math>th harmonic series when the pulse width is <math>1/n</math>. The example on the left lacks 3rd, 6th, and 9th harmonics because the pulse width is <math>1/3</math> (33%).</p>	
	<p>Square wave one octave lower than the DCO's ()</p>		

Pulse Width

► Manual PWM

PWM MODE SWITCH ② → MAN

PULSE WIDTH ③ → Determines the Pulse width.

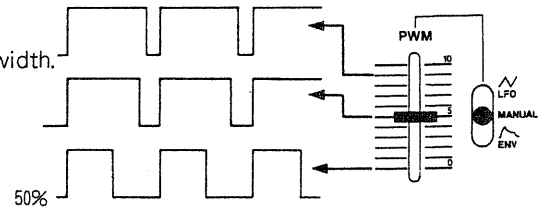

► PWM by LFO

PULSE MODE SWITCH ② → LFO

PULSE WIDTH MODULATION ③ →

Adjusts the intensity of modulation.

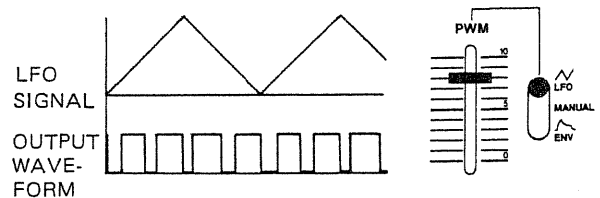

► PWM by ENV

PWM MODE SWITCH ② → ENV

PULSE WIDTH MODULATION ③ →

Adjusts the intensity of modulation.

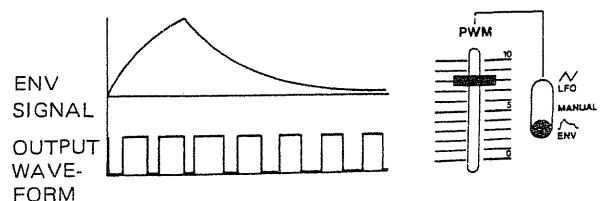

## HPF

(High Pass Filter)

This filter lets the high frequency harmonics pass and cuts off the low frequency harmonics. As this filter is not voltage controlled, Cutoff Point is changed by only moving the knob.

① **FREQ • Cutoff Frequency**

Cutoff Point of HPF can be adjusted with this knob. As you raise this knob, frequencies in the low pitch range will be cut off.

## VCF

(Voltage Controlled Filter)

This filter changes the tone color by cutting off or emphasizing harmonics. This filter lets the low frequency harmonics pass and cuts off the high frequency harmonics, and is controlled by a voltage.

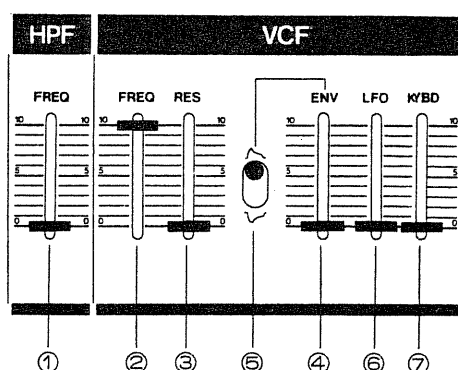
② **FREQ • Cutoff Frequency**

This knob is to change the Cutoff Point of the VCF. As you lower the knob, the frequency in the high pitch range will be cut off, and the sound will fade out when the waveform becomes nearest to a Sine Wave.

※  → Refer to P.15

③ **RES • Resonance**

This control emphasizes the Cutoff Point set by Cutoff FREQUENCY knob ②. As you raise the knob, certain harmonics are emphasized and the created sound will become more unusual more electronic in nature. If you alter the Cutoff FREQUENCY knob while the RESONANCE is set to a high level, you can create a type of sound that is attainable only from a synthesizer. If you raise the RESONANCE up to the maximum, VCF will start Self Oscillation.

④ **ENV • Envelope Modulation**

When the Cutoff Point of the VCF is being modulated by the output of the Envelope Generator, this knob is used to adjust the intensity of the modulation. You can change the Cutoff Point of the VCF in each note with the ADSR pattern previously set. So the tone color of one note can be changed quite drastically.

⑤ **Polarity Switch**

This is the selector switch for the polarity of the Envelope. When it is set at reverse polarity, the ADSR pattern will be reversed and the tone color alteration will be the other way round.

\*NOTE

This often means the Cutoff Frequency of the VCF (HPF) will need to be set higher.

⑥ **LFO • LFO Modulation**

When the Cutoff Point of the VCF is being modulated by the output CV of the LFO, this knob adjusts the depth of the growl or wah effects.

⑦ **KYBD • Key follow**

When the Cutoff Point is being controlled by the KYBD-CV (Keyboard control voltage), this knob adjusts the level of the KYBD-CV. It prevents any inconsistency in the harmonic content caused by pitch alteration. Consequently this knob is usually set to the maximum on such a long keyboard, but can be set to your taste.

\*NOTE

Self oscillation of the VCF does not guarantee accurate pitch. So, you cannot obtain correct scale when playing the Keyboard.

Cutoff Frequency

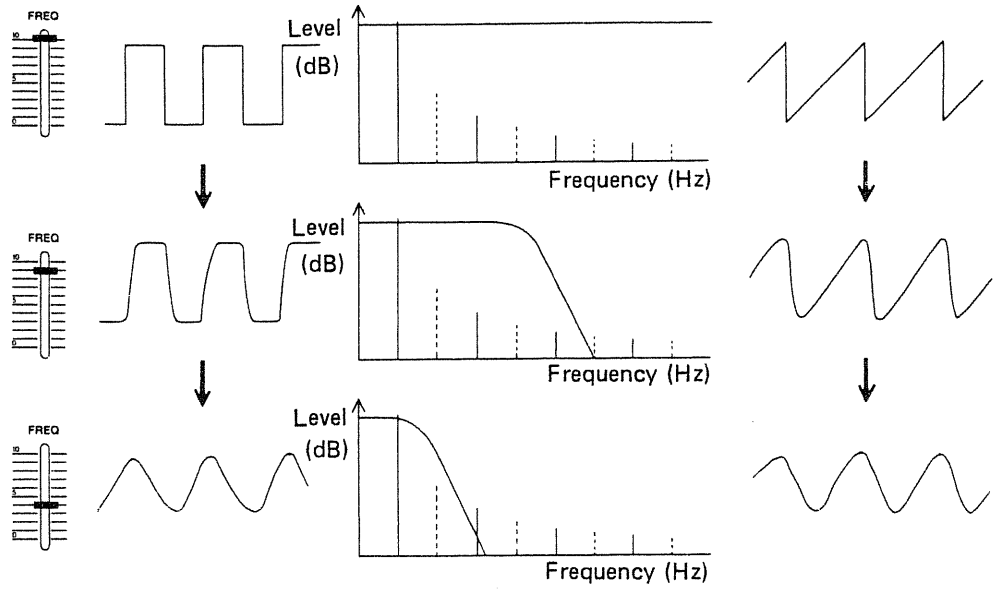

Resonance

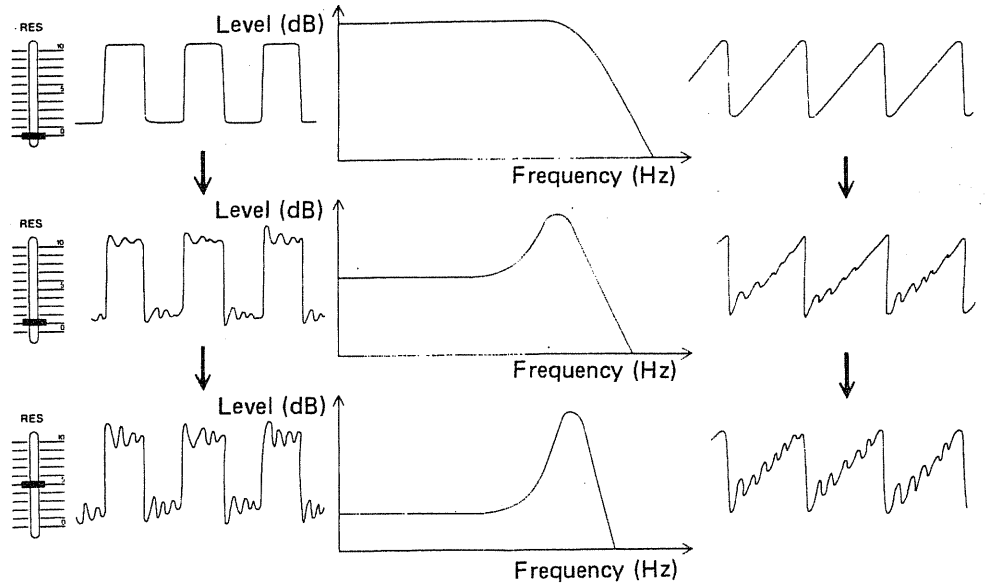

ENV Modulation

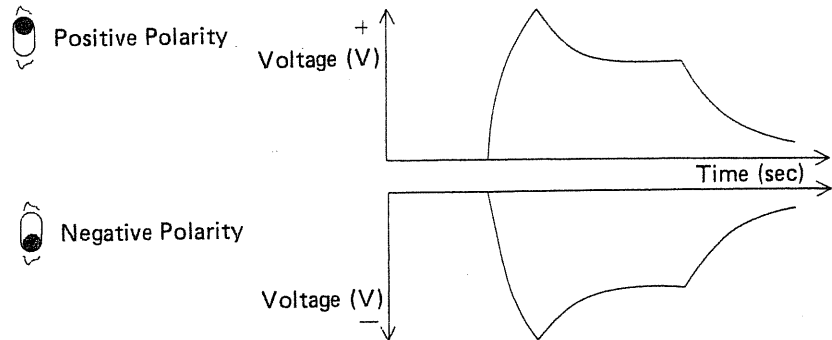

► NOTE

When modulating the VCF using the Envelope, set the knob ② to a fairly low level in case of positive polarity, and set it to a fairly high level in case of negative. Otherwise there will be little effect.



VCA  
(Voltage Controlled Amplifier)

This is to control the volume (amplitude) of the sound, and is normally controlled by the output voltage from the Envelope Generator.

① Select switch for the control signal  
This switch enables you to select whether to control the VCA by the signal from the Envelope Generator or by the Gate signal.

ENV  
(Envelope Generator)

This generates the Control Voltage applied to the VCF and the VCA, thereby controlling the volume and the tone color of each note. This output voltage is generated whenever you press a key.

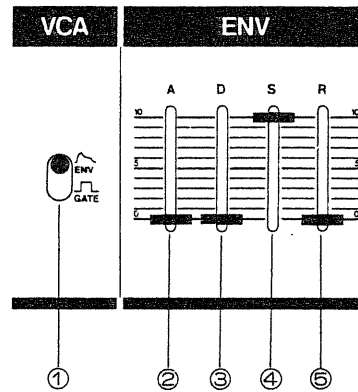

② A (Attack time)

This sets the time required for the voltage to reach its maximum from the moment the key is pressed down.

④ S (Sustain level)

This knob determines the Sustain Level to which the voltage falls at the end of the Decay Time.

③ D (Decay time)

This determines the time required for the voltage to drop from the maximum to the sustain level. When the sustain level is high, the Envelope curve does not change by adjusting the Decay Time.

⑤ R (Release time)

This sets the time needed for the voltage to reach zero.

■ ENV OUTPUT (ADSR)

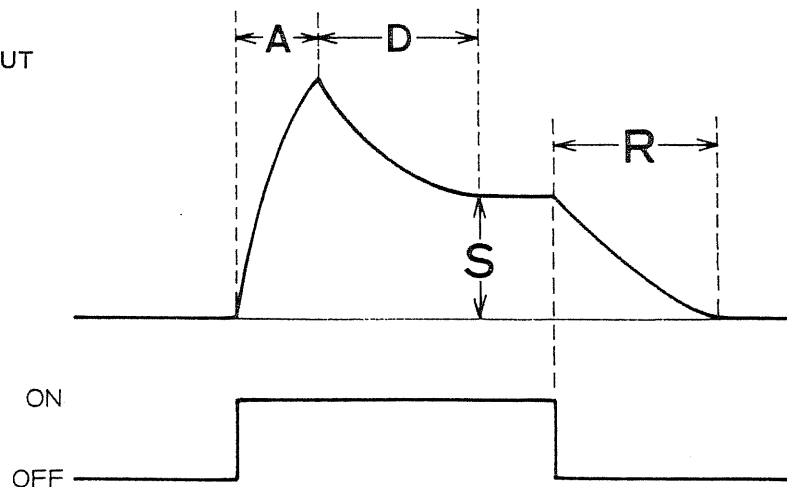

- The variation of each knob.

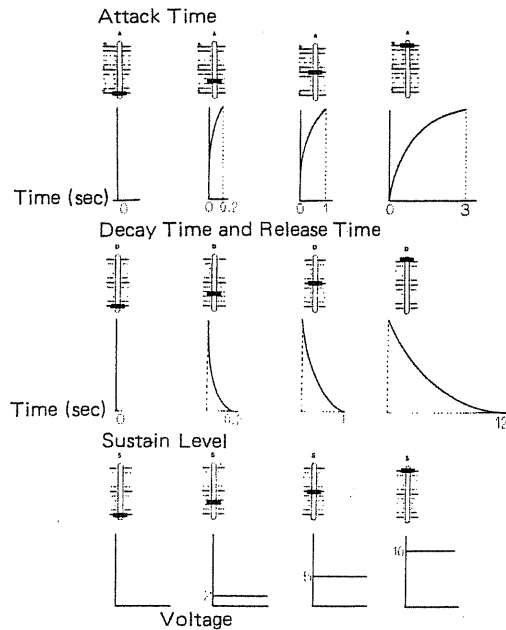

\* In the figure shown above, the positions of the knobs are not meant to be exactly correct, so the knob position does not necessarily correspond with the time and the voltage.

- Setting of ADSR and Envelope Curve.

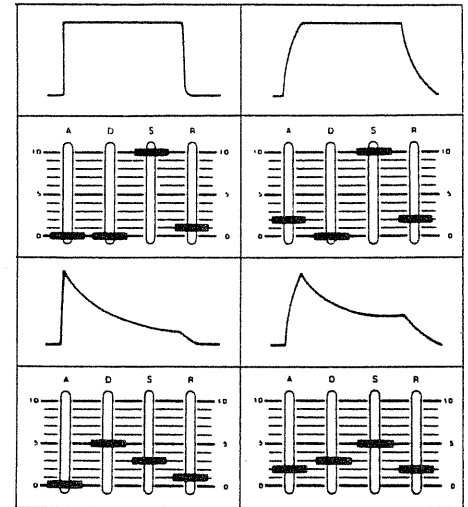

\*\* When all of the ADSR sliders are set at "0", the waveform will be an extremely short Pulse wave, and only a short "click" is heard. Please be careful.

**LFO**  
(Low Frequency Oscillator)

This oscillator operates only at a Low Frequency. It controls the VCO and the VCF to produce vibrato and growl effects.

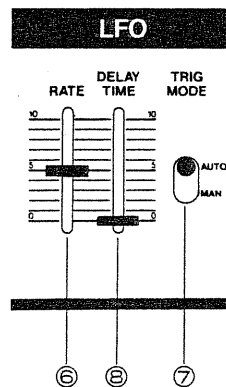

⑥ RATE

This adjusts the rate of LFO.

⑦ TRIG MODE • Trigger mode switch

You can select whether to operate the LFO manually or automatically.

⑧ DELAY TIME

This sets the time needed for the LFO to start to function. The function varies depending on the position of the TRIGGER MODE switch ⑦.

TRIG MODE		AUTO	
DELAY TIME	0	LFO always functions.	The LFO works while the LFO TRIGGER button is being pressed and stops when the button is released.
	Other than 0	The LFO does not start to function until the Delay Time set with the DELAY TIME has passed. (*)	While the TRIGGER button is being pressed, the LFO amplitude becomes larger. When the delay time set previously has passed, it becomes normal amplitude.

\*: This Delay function works only in non-legato manner. So the Delay Time affects only the first key in a legato section.

### KEYBOARD

The Roland Juno-6 has 5 octaves and 61 keys, but can be played as a 7 octave keyboard (as shown below) by using the TRANSCOPE switch. When the TRANSCOPE switch is set to Normal, the third C from the bottom

corresponds to the Middle C of a piano keyboard. So, if you wish to use the Juno-6 with the other keyboards, this knowledge will help you to align the Middle C of the two keyboards.

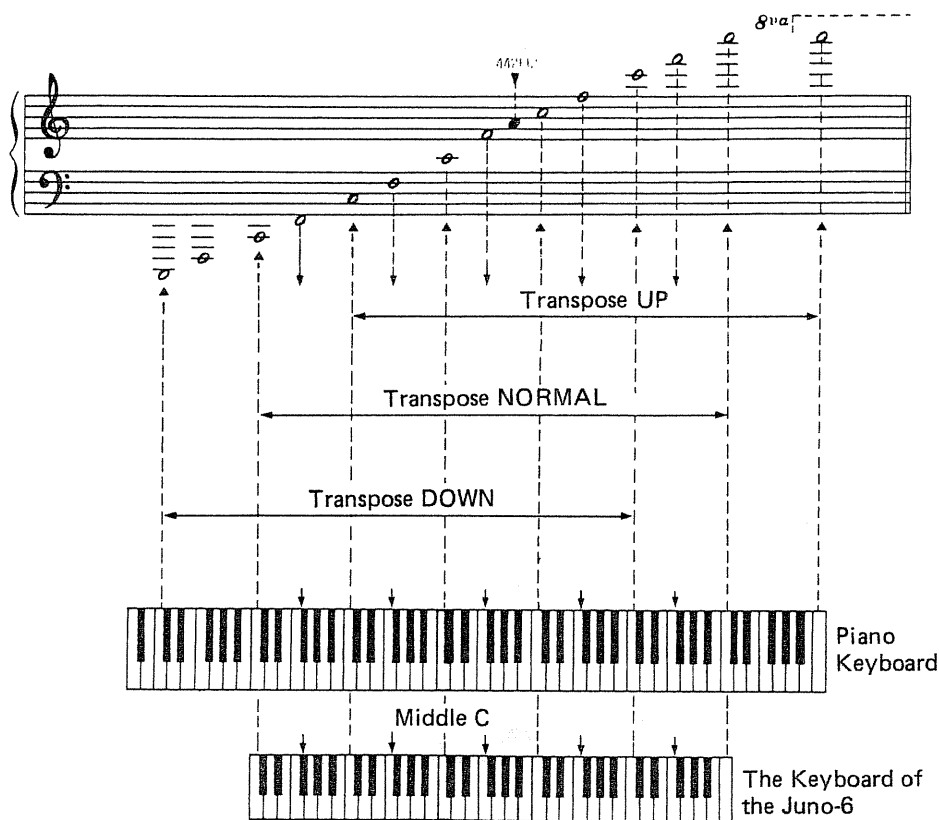

### CONTROLLERS

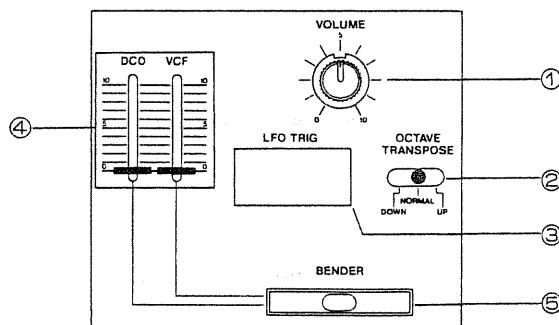

① VOLUME

② OCTAVE TRANSCOPE

This is to transpose the scale one octave up or one octave down.

③ LFO TRIG

The LFO MODULATION can be turned on and off with this button, if the LFO TRIGGER MODE switch is at (MANUAL) position. (Refer to P.11)

④ BEND

▲ DCO

When the Pitch of the DCO is being controlled with the ⑤ BENDER, this knob adjusts the variable range of the pitch.

▲ VCF

When the Cutoff Point of the VCF is being controlled with the BENDER, this knob adjusts the variable range of the tone alteration.

⑤ BENDER

ARPEGGIO

The Juno-6 allows you automatic arpeggio play with the range of up to 3 octaves.  
 \* Arpeggio Sample → P.17

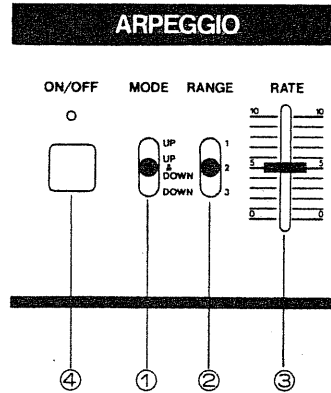

① MODE

This controls the movement of the patterns.

② RANGE

This determines the pitch range of Arpeggio.

③ RATE

This sets the speed of Arpeggio.

※ □□ (EXT CLOCK) → Refer to P.15

▲ You can enjoy wide variation of Arpeggio by combining those three controls.

④ ON/OFF • Arpeggio switch

► NOTE

\* An Arpeggio can only play while the keys are being held down unless the HOLD button is pressed.

\* Press each key of the chord at precisely the same moment, or the first pattern of the Arpeggio will be imperfect.

\* The pitch range of the Arpeggio must be within the keyboard range. So if you set the range to 2 or 3 octaves and the Arpeggio pitch range exceeds the keyboard's range, the highest pitch range will be repeated.

\* If you turn on the Arpeggio switch while holding the keys down, Arpeggio may fail to start properly. Turn on the Arpeggio switch before pressing the keys down.

RANGE, MODE

• Arpeggio Patterns in case of 

RANGE \ MODE	1 oct	2 oct	3 oct
UP			
UP / DOWN *			
DOWN **			

\* Occasionally, the first octave may take a while to "settle in" if you use the DOWN mode.

\*\* Also, in the Down mode, if you change from either of the other two modes, the last note of the previous mode will become the first note of the Down mode.

## HOLD

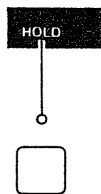

※  → Refer to P.15

When this button is pressed, the sound remains even after you release the key. The level of the sound is controlled by the S (Sustain Level) in the Envelope Generator. Consequently you cannot hold a sound that has a SUSTAIN level of zero.

Also, the HOLD function applies up to 6 keys at a time, and if more than 6 keys have been played, the last six keys will remain.

## ARPEGGIO &amp; HOLD

If you press the HOLD button while an Arpeggio is being played, it will continue to be played even after the keys are released. In this case, no matter how many keys are pressed, each time you press a new key, you will hear a new Arpeggio with a different pattern.

## ▲ NOTE

Turn the ARPEGGIO switch on before turning on the HOLD switch. If you turn on or off the ARPEGGIO switch with the HOLD on, the previous pattern may be played, which makes operation awkward.

## KEY TRANSPOSE

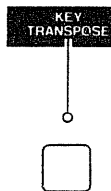

## ■ How to transpose

While holding the TRANSPOSE button down, press any key in any octave. If the indicator above lights up, transposition is completed and the Juno-6 will now play in the key of the chosen note.

\* Normally C cannot be transposed, only the highest C can be transposed one octave up. (The indicator lights up.)

Transposition to any key is possible. By using the appropriate key, you can shift the pitch of the entire keyboard. Moreover you can play a piece with many #s and b's in the key of C major (A minor).

## ■ How to return to the normal key (C key)

While holding the TRANSPOSE button down, press any C note (except for the highest C), and the indicator will go out and the Juno-6 has returned to the normal condition (the key of C).

※ Key transposition is not possible while an Arpeggio is being played.

## HOLD &amp; KEY TRANSPOSE

The sound, sustained by the HOLD function, can be transposed as well. Hold the chord then transpose as shown above. Using the top octave, you can transpose the key up by one octave.

REMOTE CONTROLS

ARPEGGIO  
CLOCK IN    PEDAL  
HOLD    VCF  
CONTROL

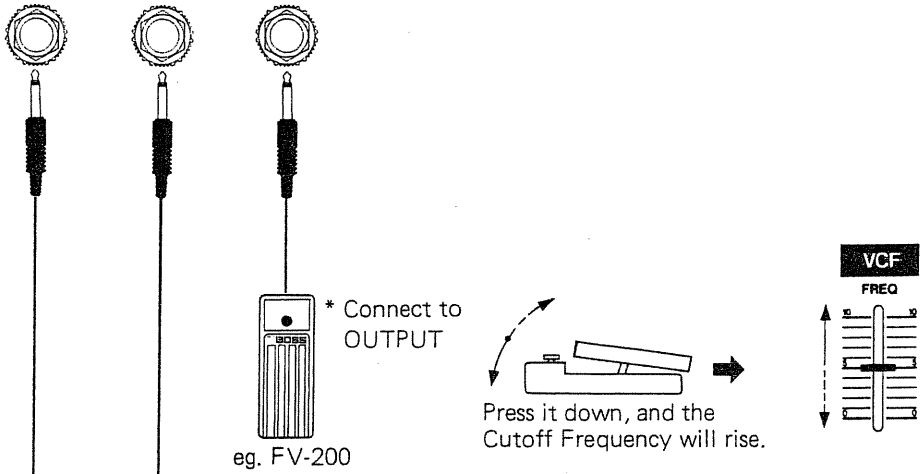

※ Keep the Hold switch (on the panel) off.

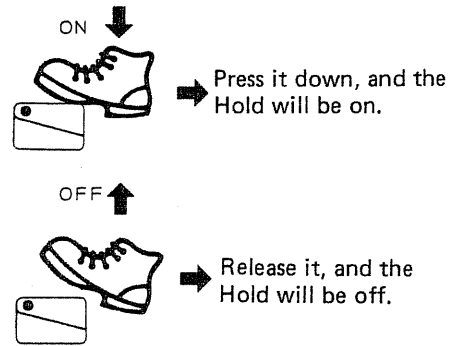

1 note per  
1 pulse

RHYTHM MACHINE  
SEQUENCER etc.

- CR-8000, 5000 ..... TRIGGER OUT
- DR-55 ..... DBS, CSQ\*
- TR-606, 808 ..... TRIGGER OUT\*
- TB-303 } ..... GATE OUT\*
- CSQ-600 } ..... GATE OUT\*
- MC-4 ..... GATE OUT\*
- MPX OUT\*

※ When it is connected to the ARPEGGIO CLOCK IN, the Arpeggio Rate knob on the panel does not function.

\* You can play Arpeggio with many kinds of patterns.

CHORUS

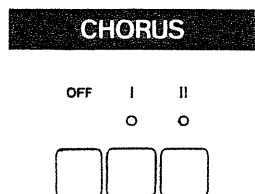





This gives spaciousness and richness to the sound. The effect becomes stronger from left to right, that is, II is stronger than I. Use the stereo output (2ch) to obtain the best effect.

Optional Effect Units

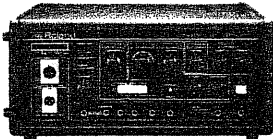
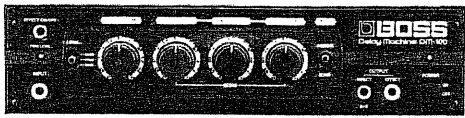
An echo chamber is most commonly used of all the effect units. It has such a strong effect that it is often said to be indispensable when using synthesizers. Effect units such as a Phaser or a Flanger have the ability to add unique changes to the

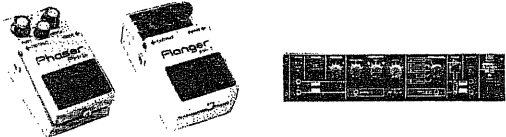
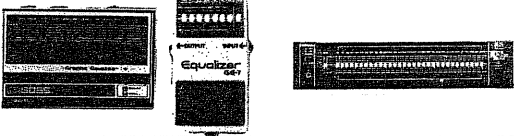
sound, and it is effective to use them with Echo Chamber. A Phaser gives an effect which can change the noise to a jet sound. A Flanger has an effect similar to a Phaser's, but stronger, and can give power to a synthesizer bass sound.

Echo Chamber		SRE-555 RE-501 RE-201 RE-150
Delay Machine		DC-30 DM-100
Digital Delay		SDE-2000
Phaser/Flanger		SPH-323, PH-1R SBF-325, BF-2
Equalizer		SEQ-331, SEQ-315 GE-10, GE-7
Reverb		RX-100
Chorus		CE-2, CE-3 SDD-320

When using Arpeggio as an accompaniment, adopt a pattern that is completed within one measure. Select the appropriate range and mode according to the number of notes in the chord, and beats in the bar.

※ The SAMPLE SCORES show the examples of when you press each note of the chord simultaneously: If there is a time gap in pressing each note, the scores will not be the same.

### 1 Three note Arpeggio (1 oct. UP/DOWN)

### 2 Three note Arpeggio (2 oct. UP)

### 3 Three note Arpeggio (3 oct. UP/DOWN)

### 4 Four note Arpeggio (1 oct. UP/DOWN)

### 5 Four note Arpeggio (2 oct. UP)

### 6 Five note Arpeggio (1 oct. UP/DOWN)

### 7 Arpeggio with a Bass note (1)

- Press one Bass note with the left hand and three notes of the chord with the right hand.

### 8 Arpeggio with a Bass note (2)

- Press one Bass note with the left hand and three notes of the chord with the right hand.

### 9 Special use of Arpeggio Mode (Bass Pattern)

### 10 Special use of Arpeggio Mode (Tremolo I, II)

#### Tremolo I

- Play a single note and adjust the speed of tremolo with the RATE control. Lower the Sustain Level and shorten the Decay Time. Organ like sound is obtained by adjusting ENV.

#### Tremolo II

- Tremolo with xylophone like octave sound.



(About the Example patches)

The position of each knob in the diagram is not meant to be exact, and the sound can differ drastically with any slight change of the knob positions. It also varies depending on the type of the speaker and the amplifier connected to the Juno-6. Please adjust the

settings while actually playing. Also, set the CHORUS button to the level you prefer while listening to the sound.

\* The "missing" knobs in the diagrams are irrelevant to the sound, and can be set to any position.

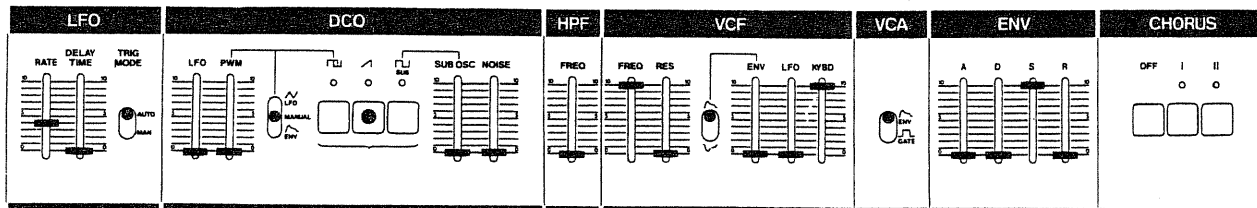

↑ When you get confused with operations or no sound comes out, return to this basic setting and start again.

## [1] GROUP STRINGS I

The sound of a small group of strings. Adjust the FREQ and ENV in the VCF. Also, you

can get a vibrato effect by raising the LFO knob in the DCO.

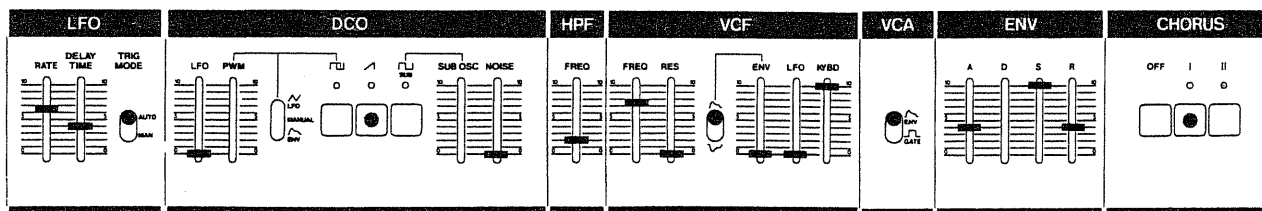

## [2] GROUP STRINGS II

The sound of a medium group of strings. Turn on the SUB in the DCO and set the FREQ in the HPF to '0', and the sound of a large group

of strings is obtainable. Set the Chorus as you like.

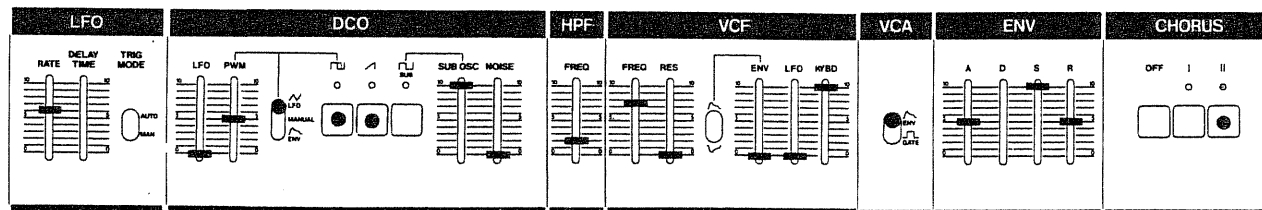

## [3] ORCHESTRAL STRINGS

A mild ensemble sound. Adjust the FREQ in the VCF and A (ATTACK) in the ENV. Vi-

brato effect can be obtained by setting the LFO in the DCO fairly high.

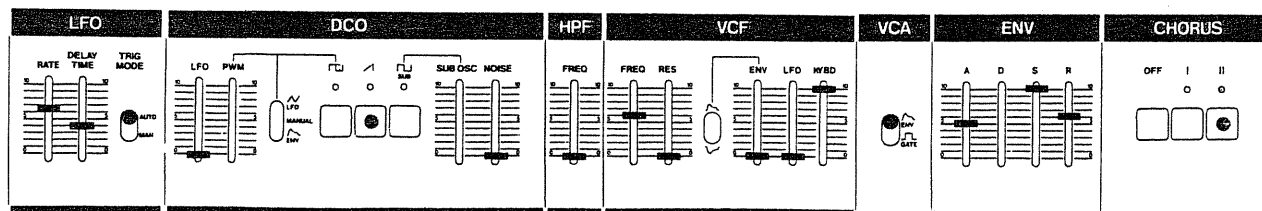

[4] JAZZ ORGAN

With the ADSR controls all at '0', control the VCF so that a key click sound will be generated. By turning on the CHRUS II at

the same time, you can obtain an effect similar to a revolving speaker (FAST).

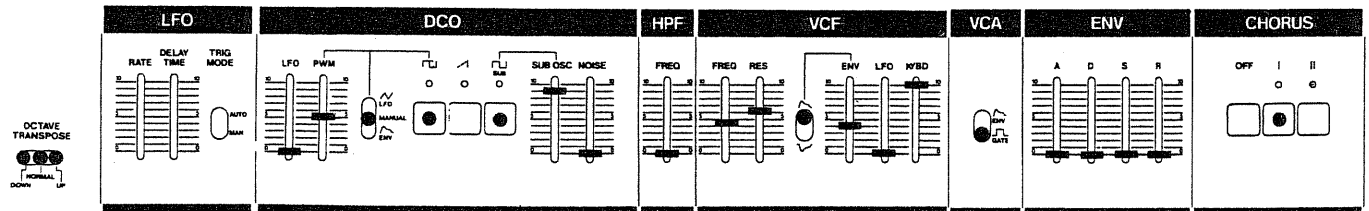

[5] CHURCH ORGAN

A thick, church organ like sound. The tone color widely varies depending on the position of the FREQ in the VCF.

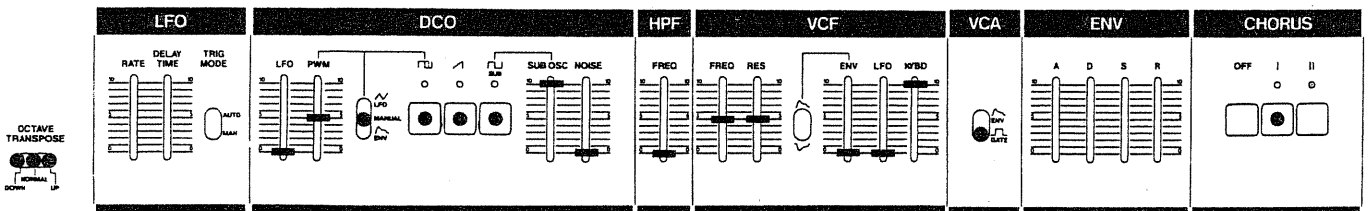

[6] HOME ORGAN

The sound of Electric Organ for home use. You can adjust the vibrato effect (the LFO in the DCO or the RATE in the LFO) according

to your taste. The tone color can be greatly altered by changing the FREQ control in the VCF.

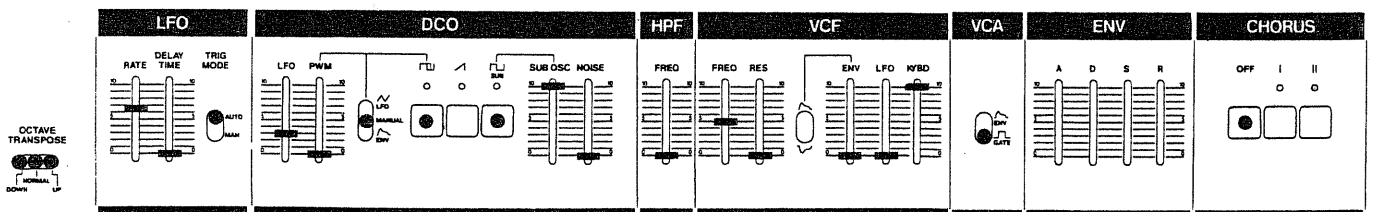

[7] SINE-WAVE ORGAN

The sound source is the sawtooth wave. If you adjust the FREQ in the VCF to the fundamental pitch and set the RES high, you can obtain a pure sine wave, as only the

fundamental content is being passed. This method should be adopted when accuracy is required, while the sine wave is also obtainable by sending the VCF to self oscillation.

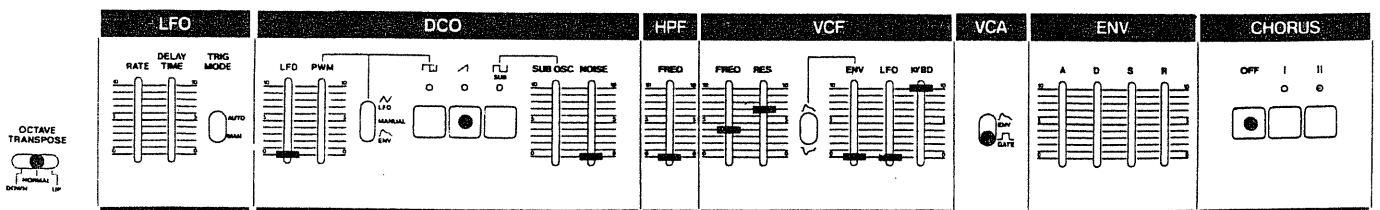

[8] SQUARE-WAVE The sound source is the square wave of the Sub Oscillator. Set the TRANSPOSE to UP.

Adding the CHORUS effect might be interesting.

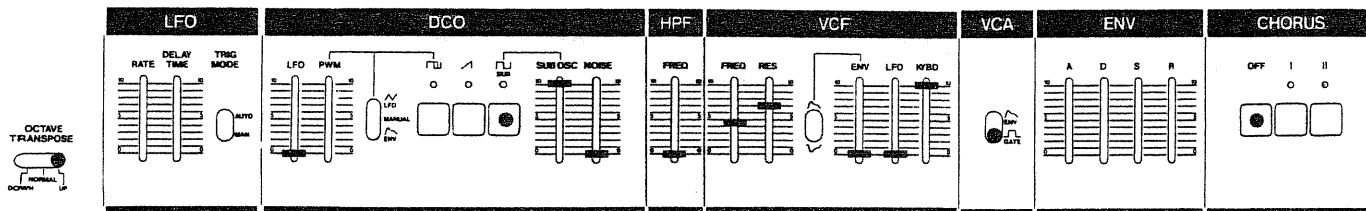

[9] STEAM ORGAN The Self Oscillation of the VCF is used as a sound source as well as the Square Wave of the DCO. Set the FREQ in the VCF to '0' and turn it up a little by little while pressing the note C. You will hear the sound of the

DCO (note C) first, and then the sound by the VCF Self Oscillation will be joined. So adjust the FREQ of the oscillating VCF until it is an octave and a 5th higher than the DCO.

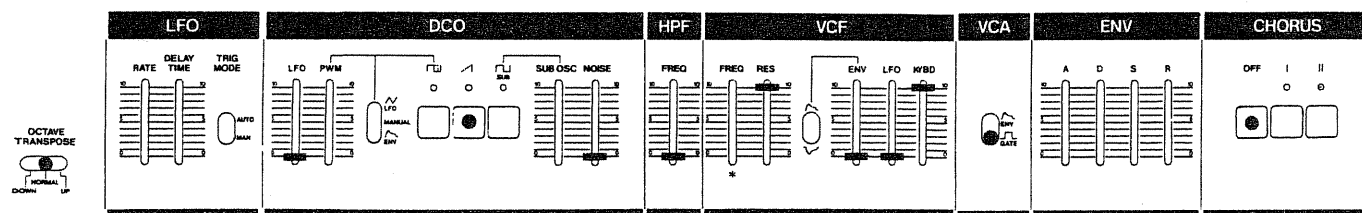

[10] ELECTRIC PIANO I Adjust the D and R in the ENV as you like. By setting the FREQ in the HPF to '0' and

turning the CHORUS II on, you can get a Honky Tonk like sound.

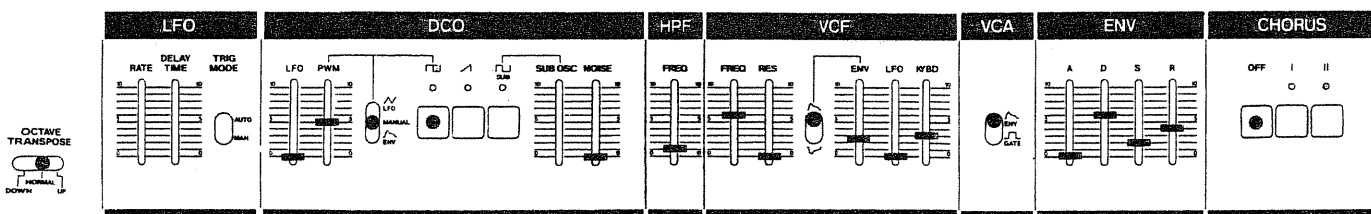

[11] ELECTRIC PIANO II This sound contains very few high harmonics. Like [7], adjust the FREQ in the VCF so that only the fundamental can pass. Adjust

the Decay Time and the Release Time in the ENV according to your preference.

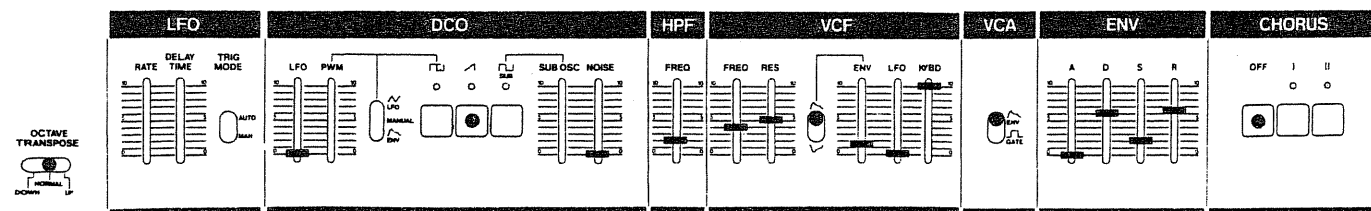

[12] HARPSICHORD    A brighter sound can be obtained by cutting the Low Frequencies using the HPF    The tone color changes drastically if you alter the PWM in the DCO.

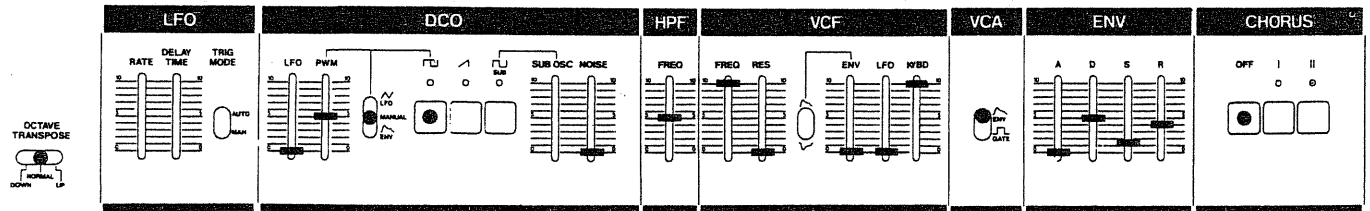

[13] CLAVI    Remember to set the TRANSPOSE switch to DOWN. The tone color can be changed widely by using the FREQ in the VCF. Setting the ENV in the VCF slightly higher might be effective.

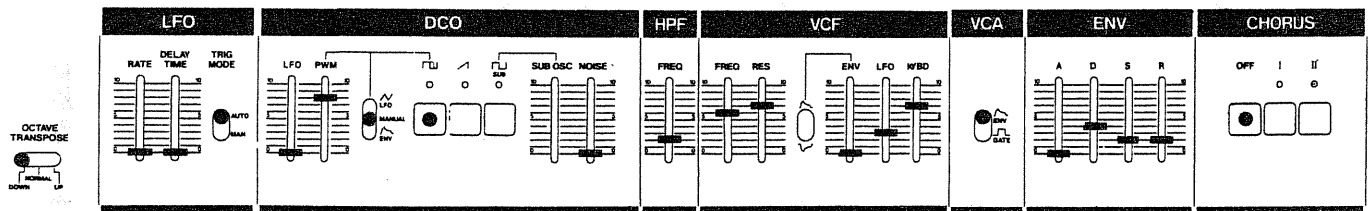

[14] GUITAR    The tone color changes according to the FREQ in the VCF. Unique sounds can be created by setting the PWM MODE SWITCH in the DCO to ENV. Adjust the RES as well.

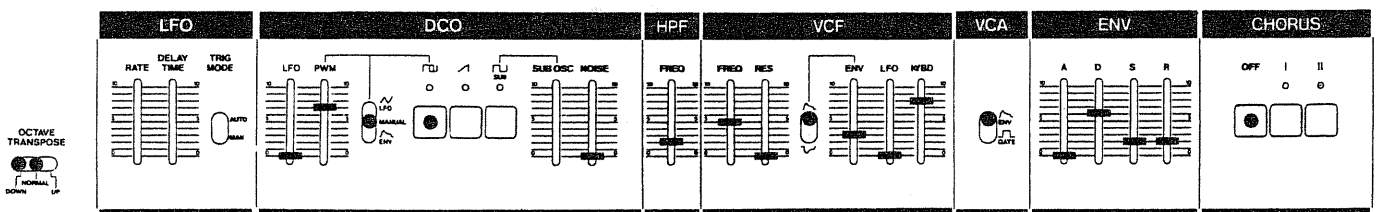

[15] SYNTHESIZER HARP    This tone color is suitable for playing Arpeggios. Adjust the FREQ in the VCF and the R in the ENV as you like.

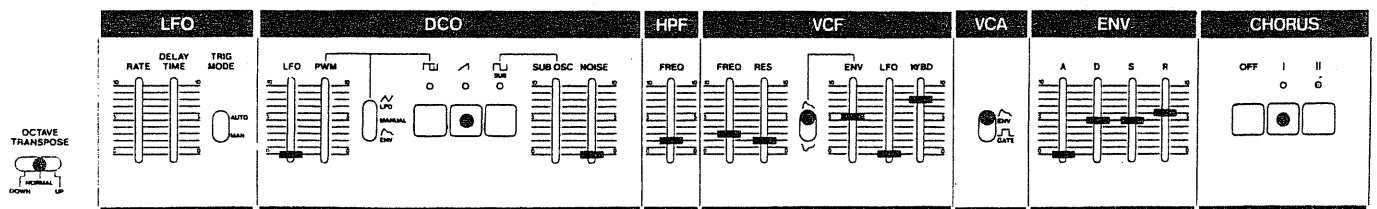

[16] WAH BRASS The settings of the FREQ in the VCF, and the ENV, are important, the Chorus effect is also pleasant.

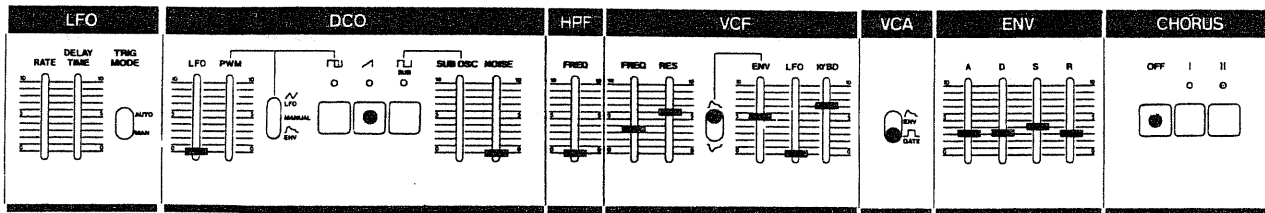

[17] PHASE BRASS You can add a wah effect by raising the RES in the VCF. Also, try changing the Attack Time with the A in the ENV. Chorus will add an interesting effect.

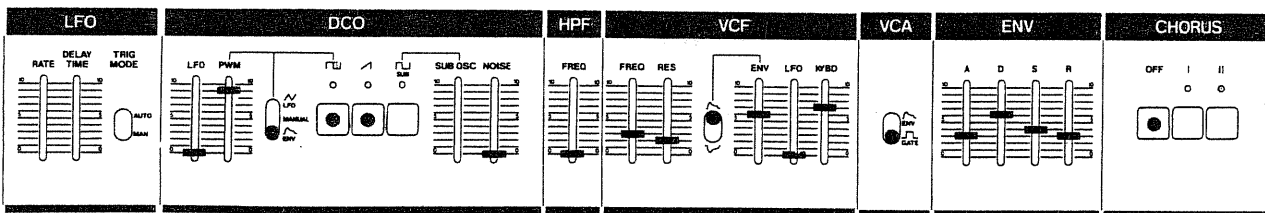

[18] FUNNY CAT The tone color changes widely by the FREQ in the VCF.

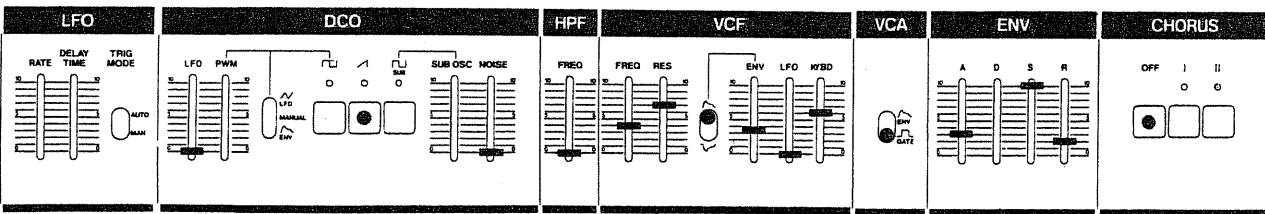

[19] PULSER As the Pulse Width is controlled by the LFO, the tone color changes periodically. The period can be adjusted with the RATE in the LFO.

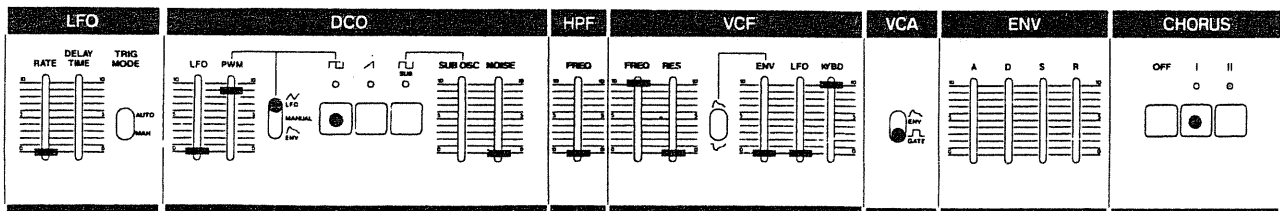

[20] PHASE COMBINATION

Adjust the ENV in the VCF.

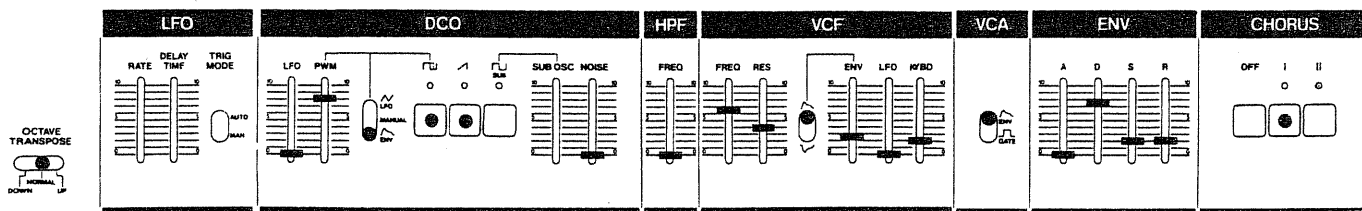

[21] SYNTHESIZER SOUND I

Different kinds of synthesizer sound are obtained by turning the ENV polarity switch

in the VCF to positive. Set the FREQ in the VCF to the appropriate position.

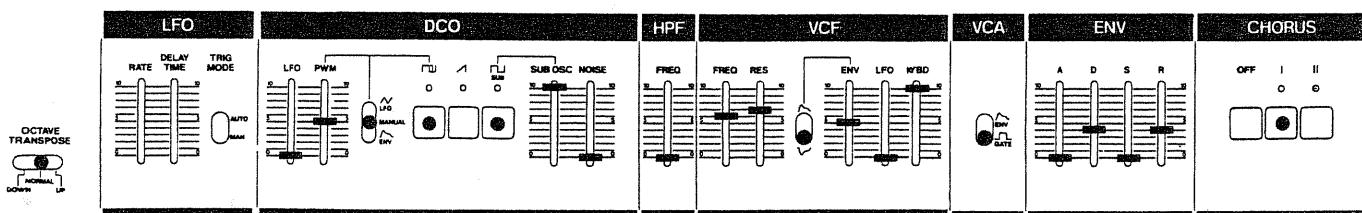

[22] SYNTHESIZER SOUND II

You can find several interesting sounds by adjusting the RES in the VCF, the polarity of the ENV, and the ENV itself.

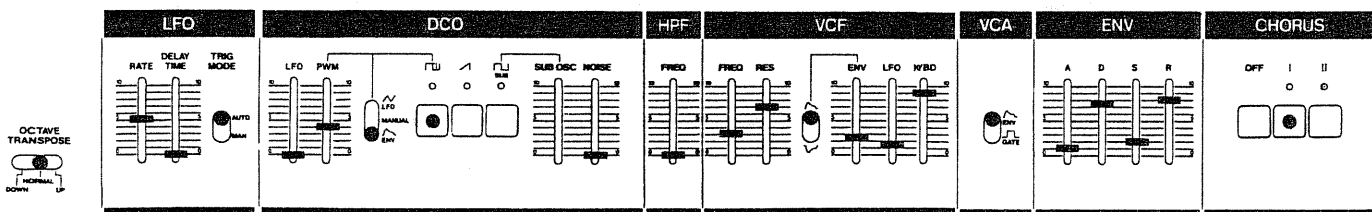

[23] MYSTERIOUS INVENTION

The impression of the sound changes depending on the position of the ENV in the VCF. Adjust the LFO in the DCO and VCF to a

desirable level. Chorus will add spaciousness to the sound.

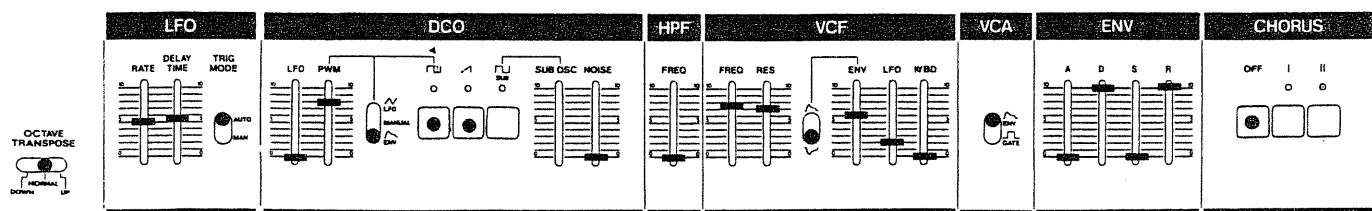

■ The following example patches are specifically single tone musical instruments. Accordingly adopt a non-legato playing manner and avoid overlapping. You can also make effective use of the BENDER.

If the effective pitch range of the sample sound is narrow, you should play within the range which allows the sample sound to represent its features properly.

## [24] VIOLIN

By adjusting the FREQ in the VCF, you can produce both hard sounds and soft sounds. Adjust the ENV in the VCF, the A in the

ENV, and the RATE and the DELAY TIME in the LFO depending on the phrase.

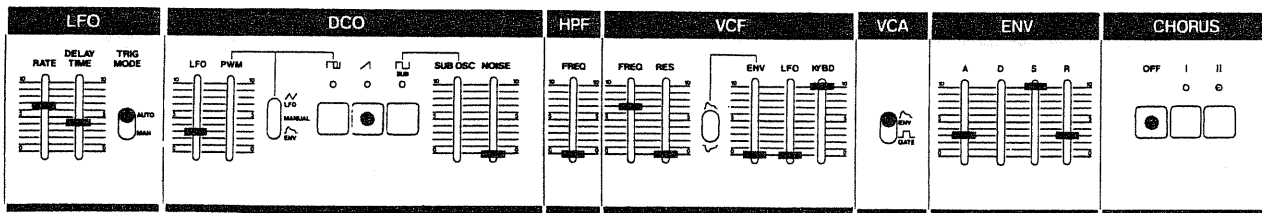

## [25] TRUMPET

By slightly moving the ENV knob in the VCF, you can subtly change the brightness of the sound. Also, you can find the TRUMPET

sound you prefer by controlling the ENV and the FREQ in the VCF.

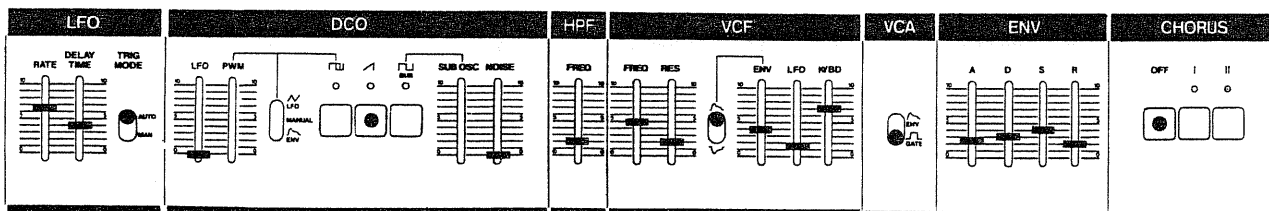

## [26] HORN

Play with the TRANSPOSE DOWN. As controlling the FREQ in the VCF is a delicate task, it should be done while you are actually

listening to the sound. Regarding any Brass sound, controlling the ENV in the VCF can change the brightness of the sound.

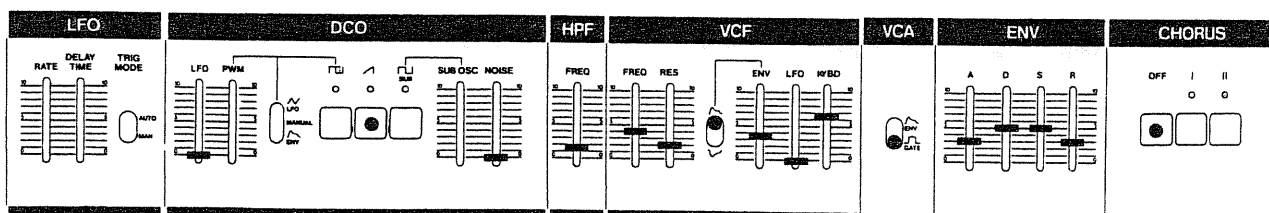

[27] TUBA

Controlling the A in the ENV is particularly important. Adjust the ENV in the VCF as well.

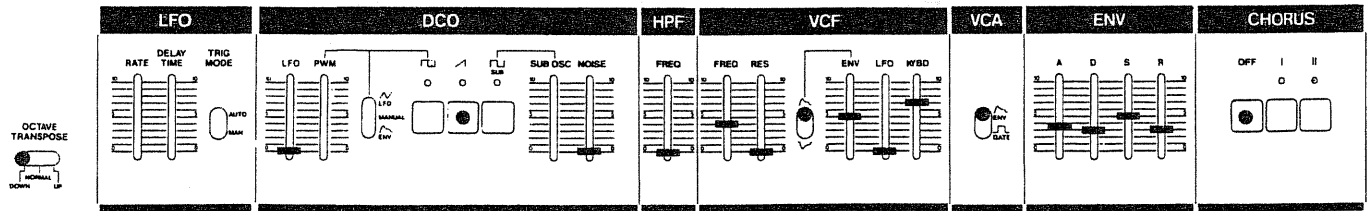

[28] FLUTE

Setting the FREQ in the VCF is critical. Also, by using the LFO in the VCF you can gain a growl effect.

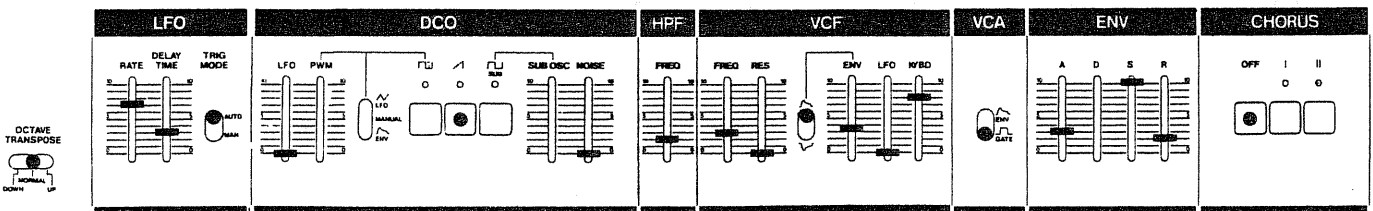

[29] CLARINET

The impression of the sound can be changed by adjusting the FREQ in the VCF. By slightly raising the LFO in the DCO, you can get a vibrato effect.

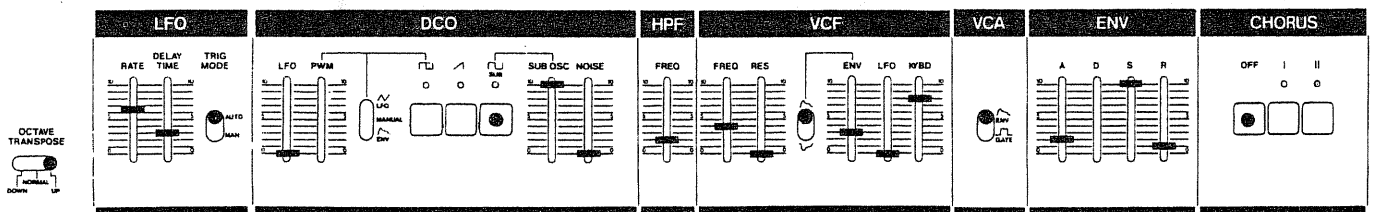

[30] OBOE

Setting the FREQ in the VCF and the RES is important. A vibrato effect is obtainable by slightly raising the LFO in the DCO.

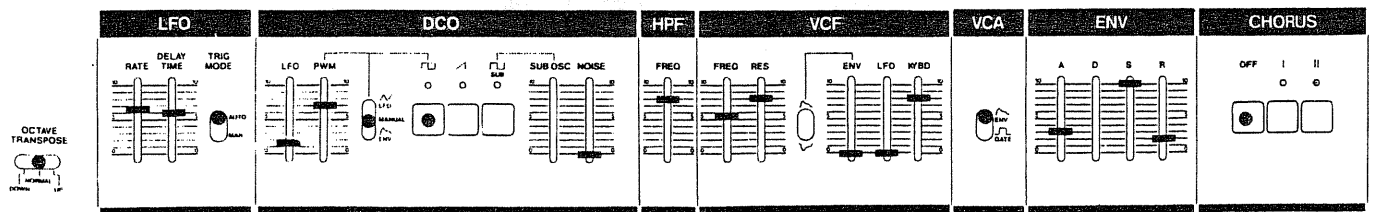



[31] SAXOPHONE

The tone color changes drastically by controlling the PWM in the DCO. Also, controlling the FREQ in the VCF, and the A in the

ENV is important. Set the LFO in the DCO, and the VCF to the desirable level.

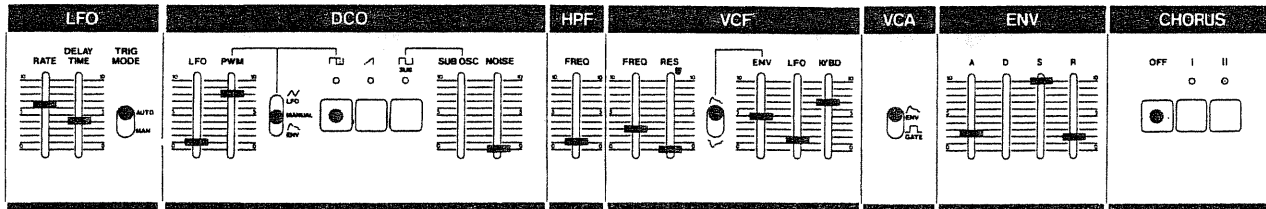

[32] BASSOON

Controlling the FREQ in the VCF, and the RES is important.

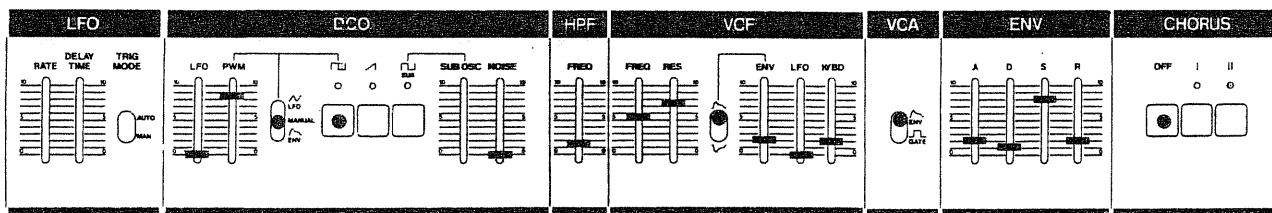

[33] XYLOPHONE

Use the SUB OSCILLATOR as a sound source and set the TRANPOSE to UP. With the Arpeggio on, a repetition effect tremolo is

obtained (RANGE → 1). If you set the RANGE to 2, an octave repetition is obtained. In this case, please play single notes.

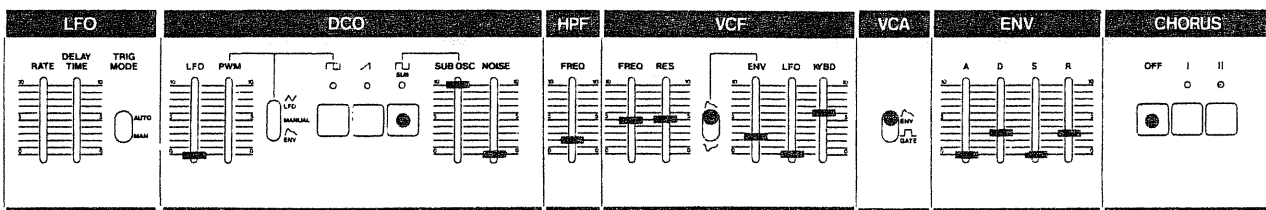

[34] GLOCKENSPIEL

Set the TRANPOSE to Up and adjust the FREQ in the VCF.

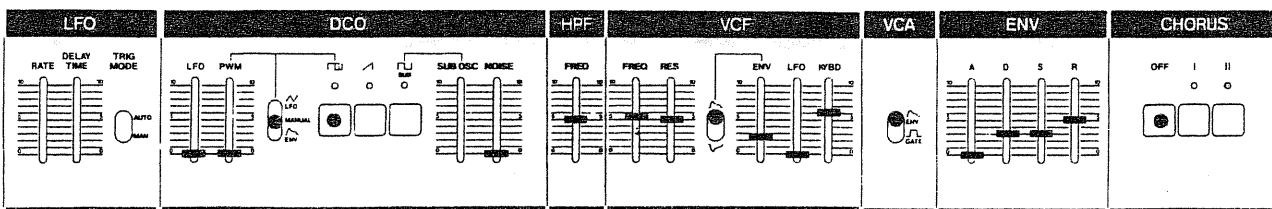

[35] PERCUSSIVE SOUND I

The pitch varies depending on which key you press, and many kinds of percussive sounds can be obtained. The impression of the sound

can be changed slightly by adjusting the D in the ENV. Adding Noise as a sound source might have an interesting effect.

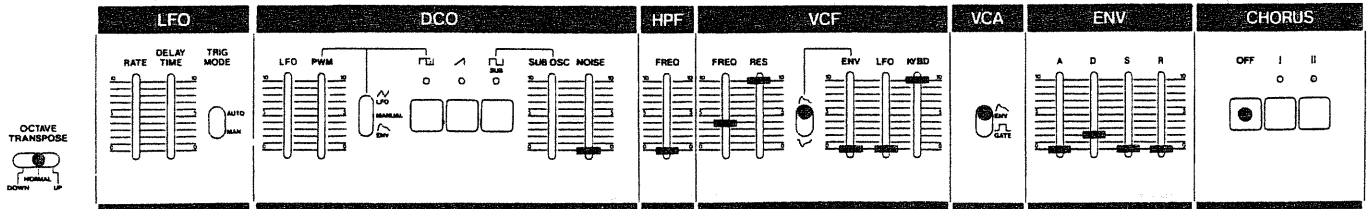

[36] PERCUSSIVE SOUND II

It is effective to add CHORUS and play in a normal way (with chords).

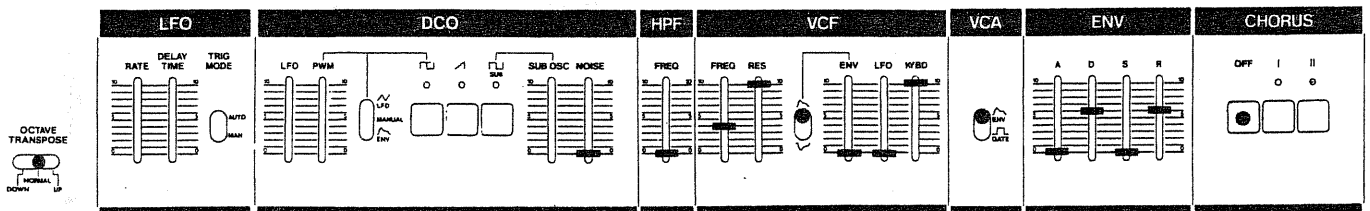

[37] SYNTHESIZER DRUM

The pitch of the drum can be changed by adjusting the FREQ in the VCF.

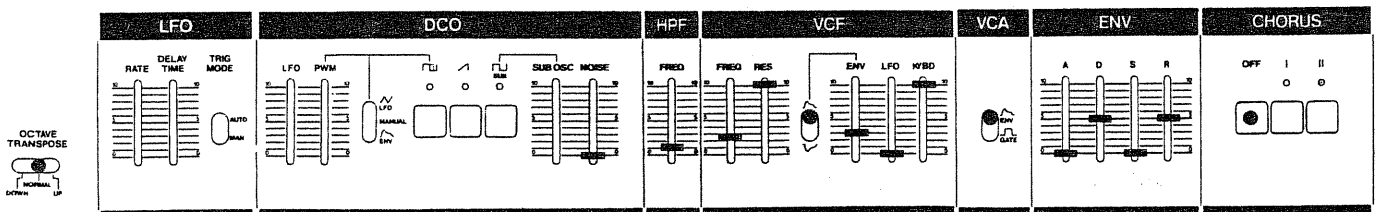

[38] WHISTLE

As the sound is made by the VCF in Self Oscillation, an accurate pitch is not necessarily obtained. When accuracy is required, adopt

the method of extracting the fundamental from the sawtooth wave of the DCO to make a sine wave (see example [7]).

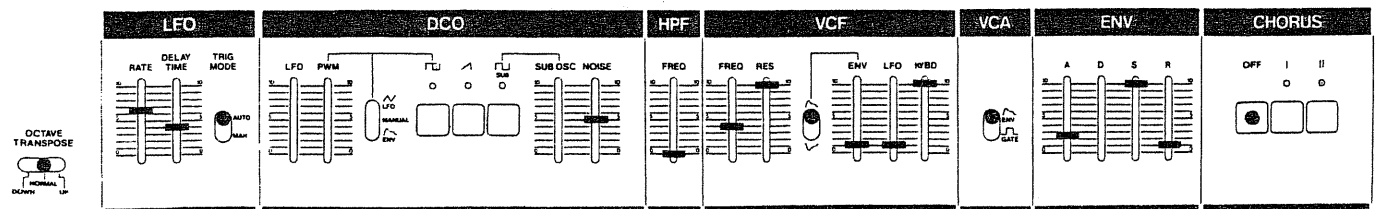

[39] BIRD CHIRPING Turn the Arpeggio on. (RANGE → 1, RATE → 6 approx.) It sounds more realistic if you move the RATE up and down.

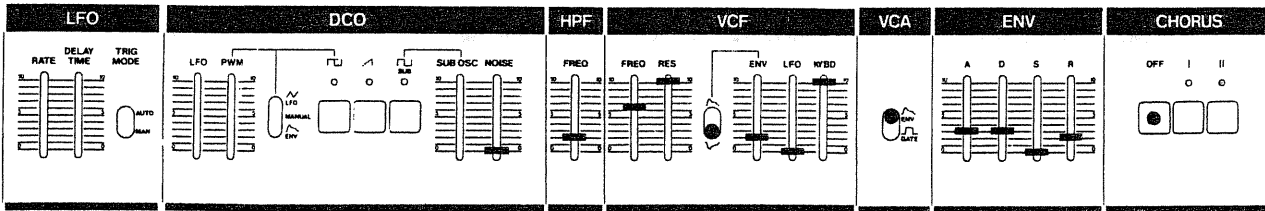

[40] DOG BARK You can make various types of Dog Barking sounds by adjusting the ENV and pressing different keys.

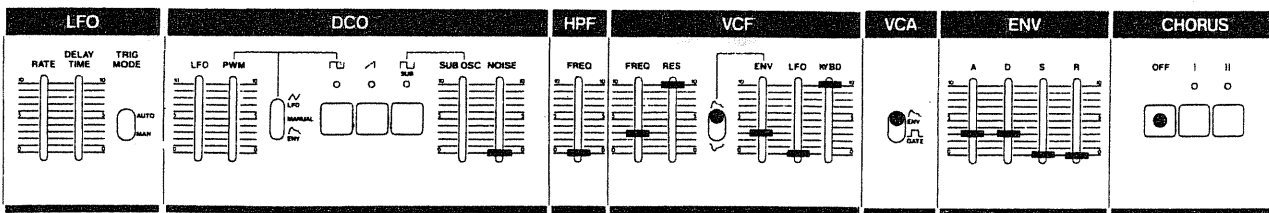

[41] SPACE SOUND Playing chords is effective.

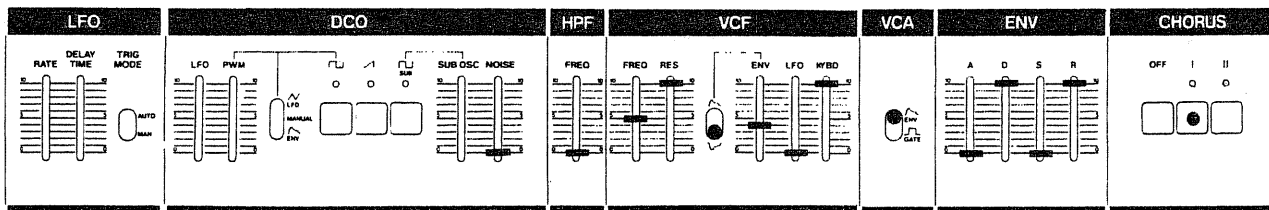

[42] WIND Keep the HOLD on, and the sound will remain even after releasing the keys. You can control the strength of the whizzing wind

with the LFO in the VCF. Playing chords may prove interesting.

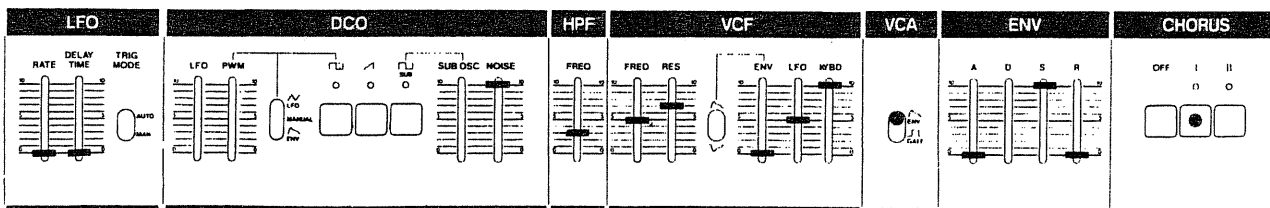

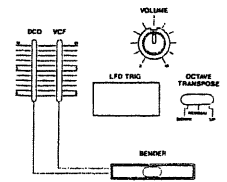
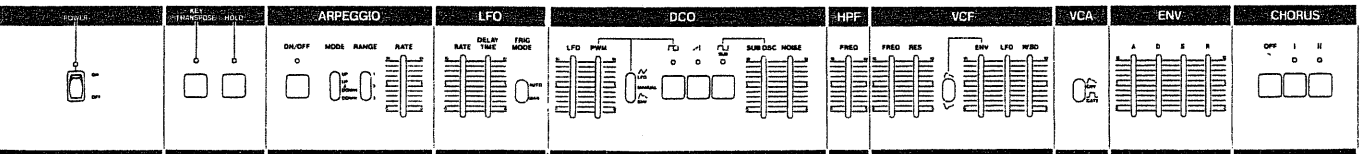
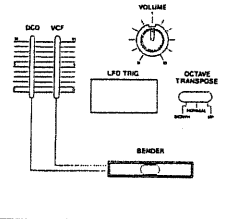
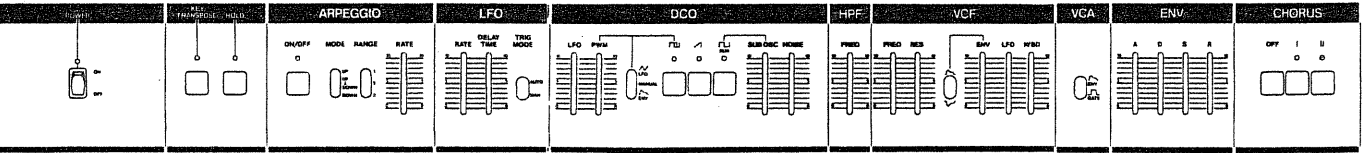
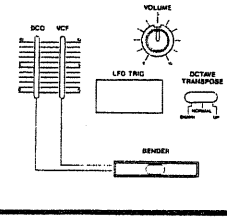
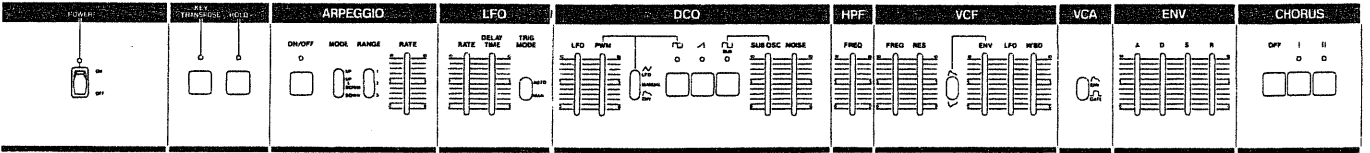
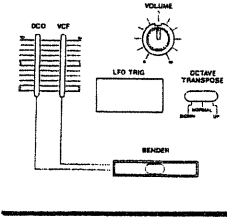
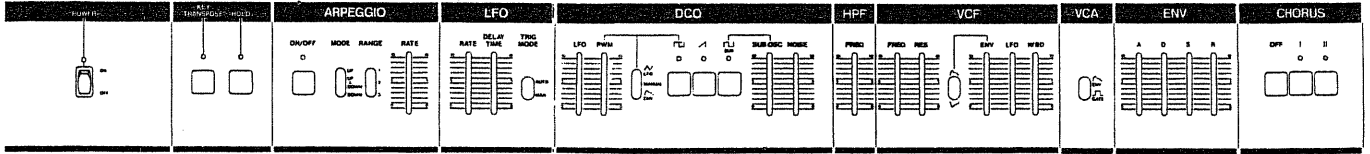

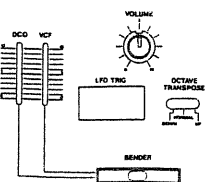
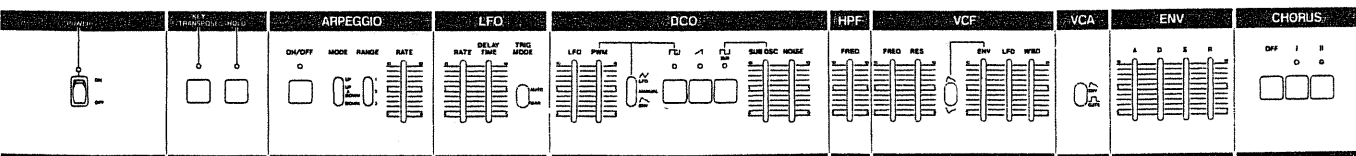
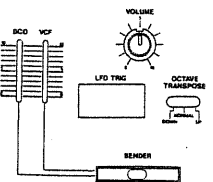
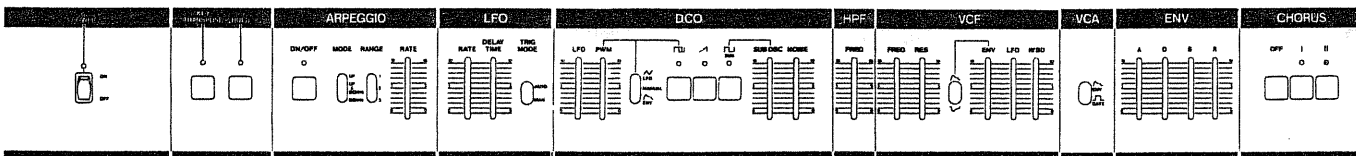
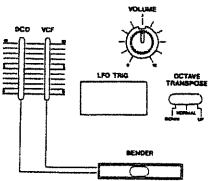
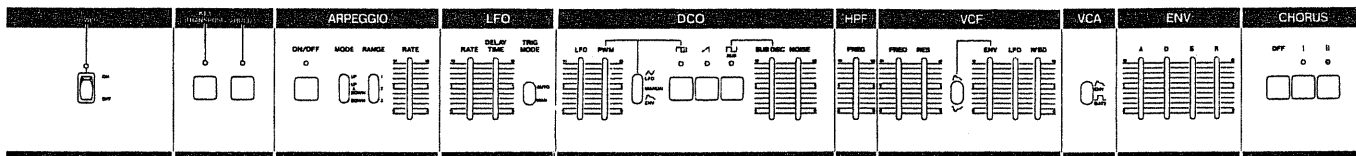
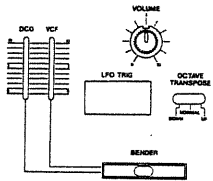
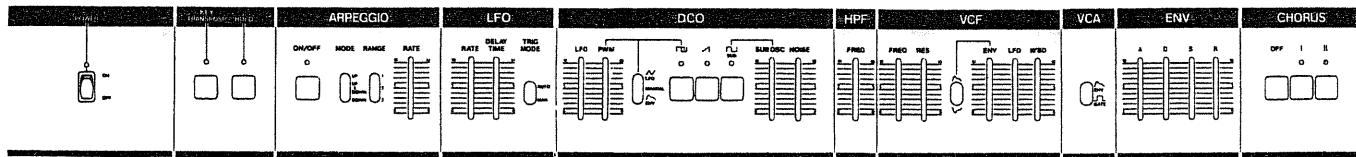

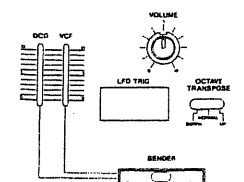
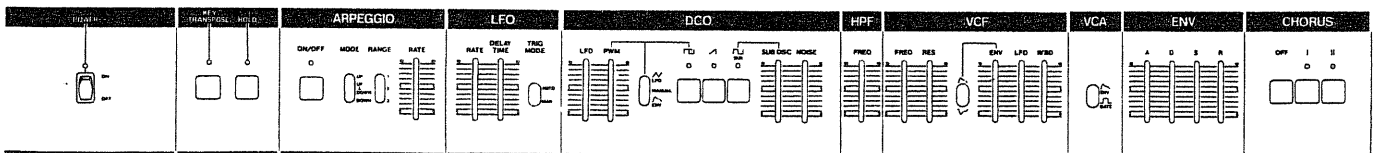
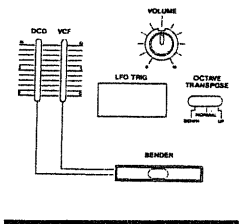
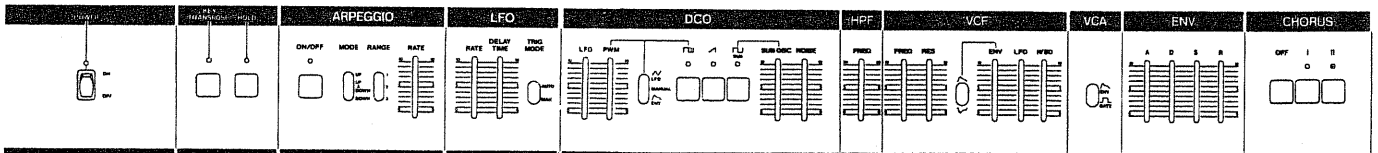
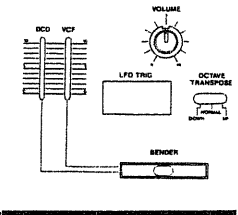
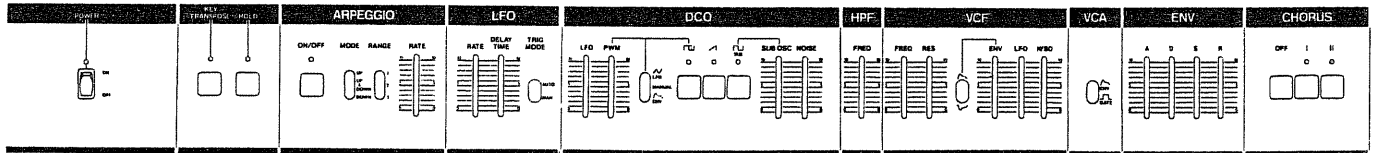
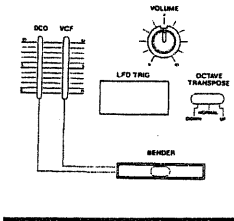
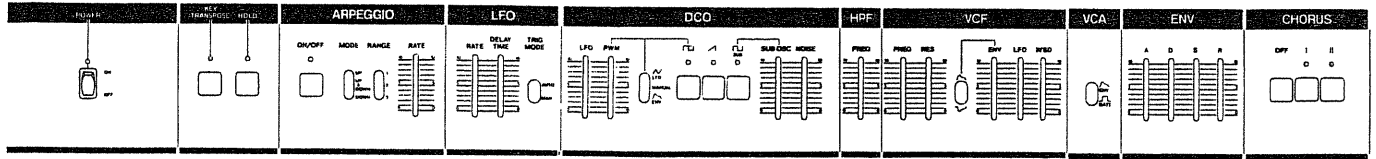









• JUNO-6 • 6 Voice Polyphonic Synthesizer

Keyboard	61 keys, 5 octaves
DCO	Waveform (     ) Pulse width modulation PWM mode switch (ENV/MANUAL/LFO) Sub Oscillator level LFO modulation Noise level
HPF	Cutoff frequency
VCF	Cutoff frequency Resonance Envelope modulation Polarity switch (   ) LFO modulation KCV follow (0 – 100%)
VCA	Control signal select switch (   )
Envelope generator	Attack time Decay time Sustain level Release time
LFO	Rate Trigger mode switch (AUTO/MAN) Delay time
Controllers	Volume Octave transpose (DOWN/NORMAL/UP) LFO trigger button DCO bend sensitivity VCF bend sensitivity Bender lever
Arpeggio	Mode switch (UP/U&D/DOWN) Range switch (1.2.3) Rate ON-OFF switch
HOLD	ON-OFF switch
Key transpose	Key transpose button
Chorus	Mode switch (OFF, I, II)
Rear panel	Output jack (mono, stereo) Output level (L/M/H) Phone jack (stereo) VCF control jack (FV-200) Pedal hold jack (DP-2) Arpeggio clock input jack (1 step/1 pulse = over +2.5V) Tune (±50 cent)
Dimensions	1060(W) X 113(H) X 378(D)mm / 41 <sup>3</sup> / <sub>4</sub> X 4 <sup>7</sup> / <sub>16</sub> X 14 <sup>7</sup> / <sub>8</sub> in
Weight	11kg / 24lb. 4oz.
Power	25W
Accessory	2.5m connection cord

\* Specifications are subject to change without notice.

- Headphones  
RH-10

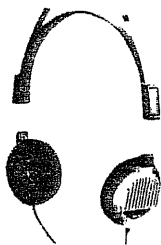

- Keyboard Stand  
KS-2

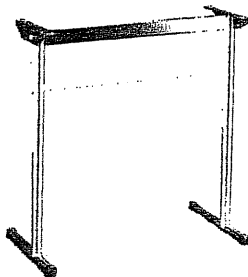

- Foot Volume  
FV-200

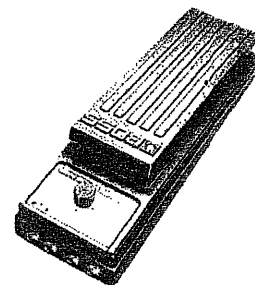

- Pedal Switch  
DP-2

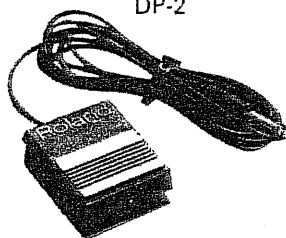

- Carrying Case  
CB-JUNO

