

VP-330 SERVICE NOTES

TABLE of PCB LAYOUT and ADJUSTMENT

CIRCUIT	PCB Page	ADJ. Page
ENSEMBLE MODULATOR ----- ETH09A	6	9
FILTER ----- FLH16/A	10/11	10
VIBRATO ----- VBH58	11	
MASTER VCO. TONE DIVIDER, GATE ----- AGH17	12	13
HUMAN VOICE ----- HVH56	12	13
PITCH SHIFT ----- OPH60	14	
JACK. MIC PRE AMP. ----- JAH59	14	
POWER SUPPLY ----- PSH42/43	15	

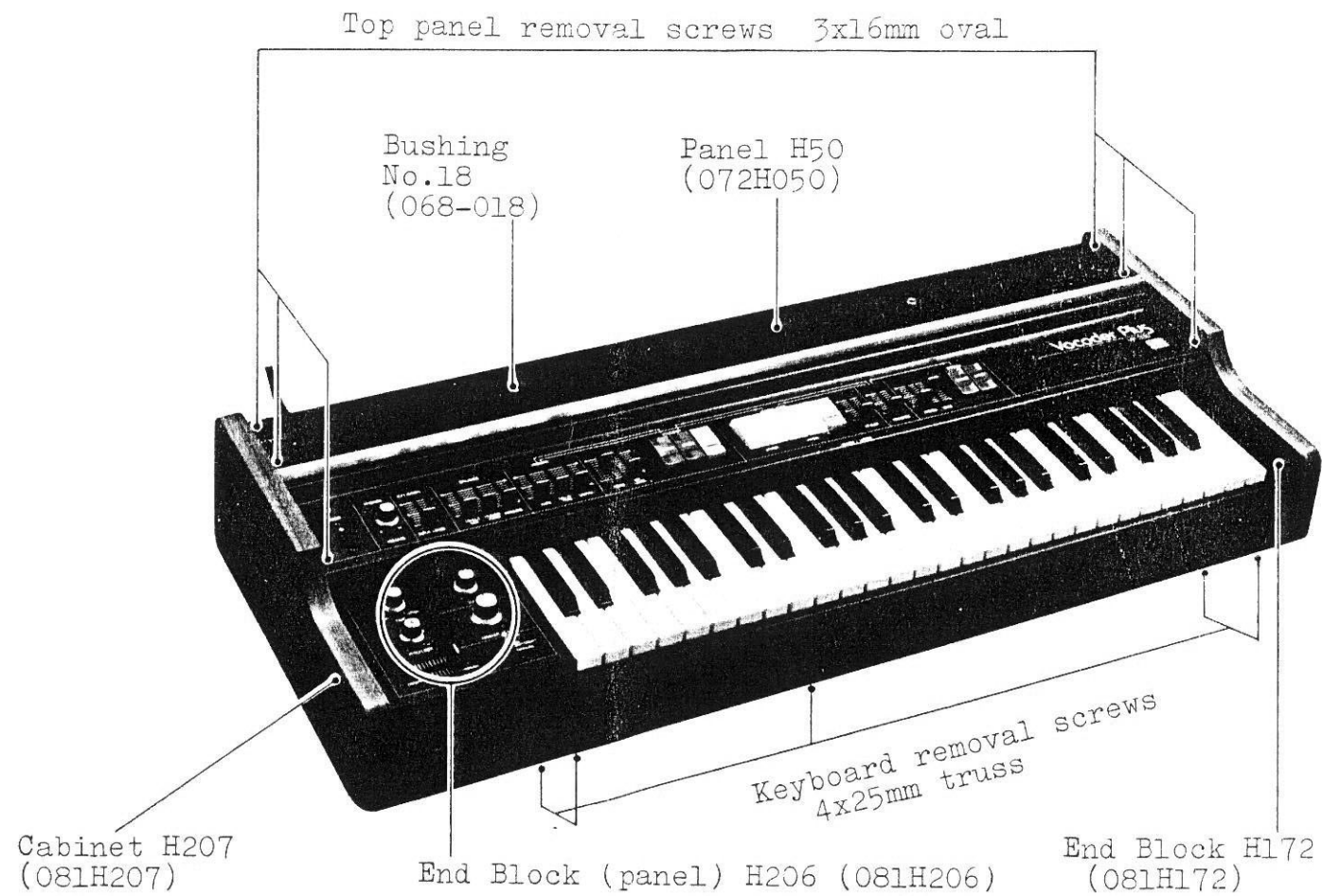

Power Switch

SDA1SA-1 (100V)
(001-258)

SDA2SA-1 (117V)
(001-259)

SDA4SA-1 (220/240V)
(001-260)

Switch SMT-039A
(022-008)

Switch SMT-059A
(022-009)

Switch SMT-029A
(022-004)

Tablets

Green (003-010)
Maroon (003-011)

White (003-012)
Gray (003-013)

* Denote legend after color when ordering

LED TLR102KB
(019-027)

Knob No.33
(016-033)

Rail H6
(110H006)

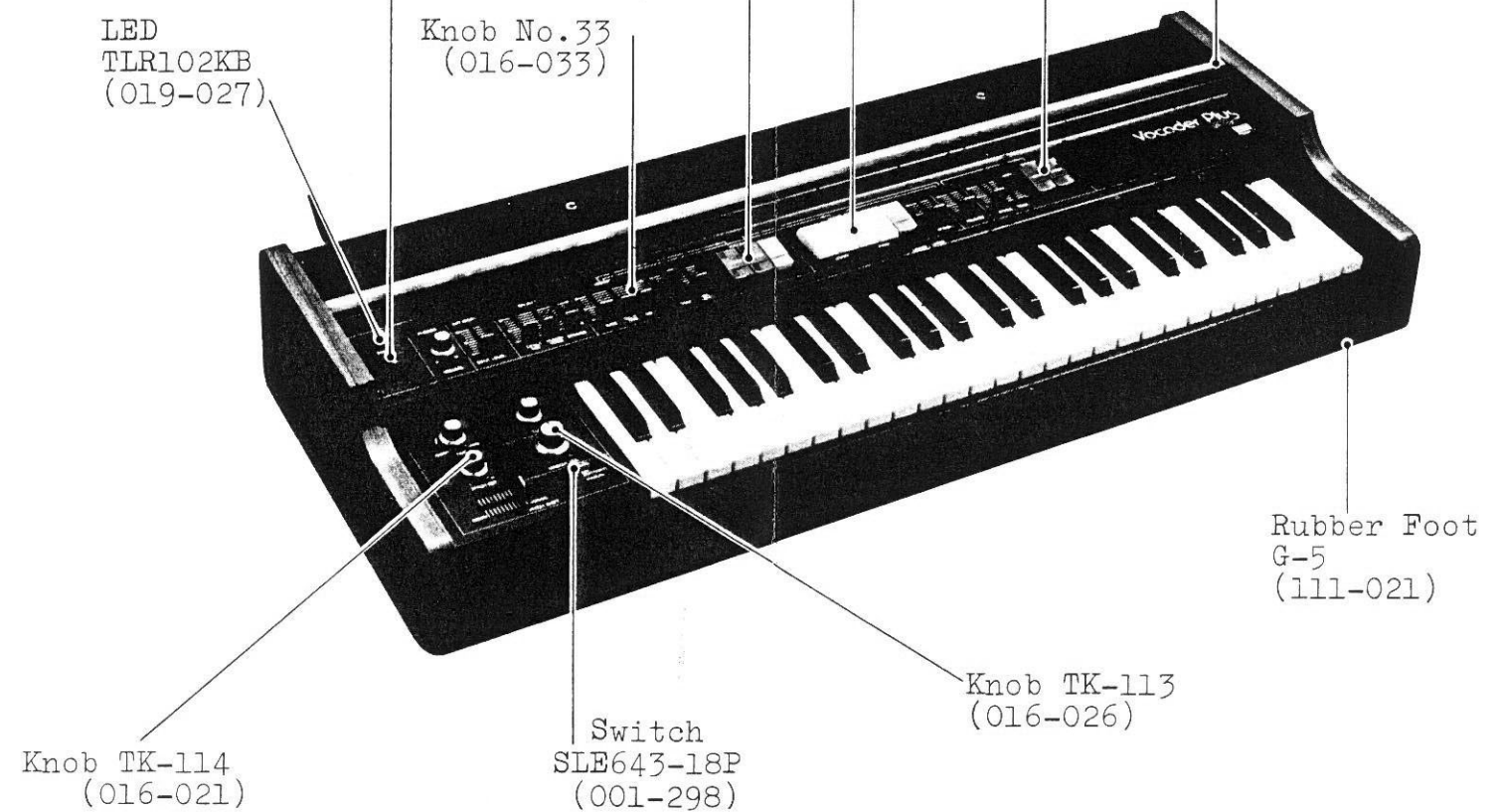

Receptacle NC-3FP or D-3M (010-264)

Screw 4x20 oval

Panel H50A (072H051A)

Jack SG7713 (009-360)

Switch HSW-0372-1-020 (001-297)

Jack SG7622 (009-012)

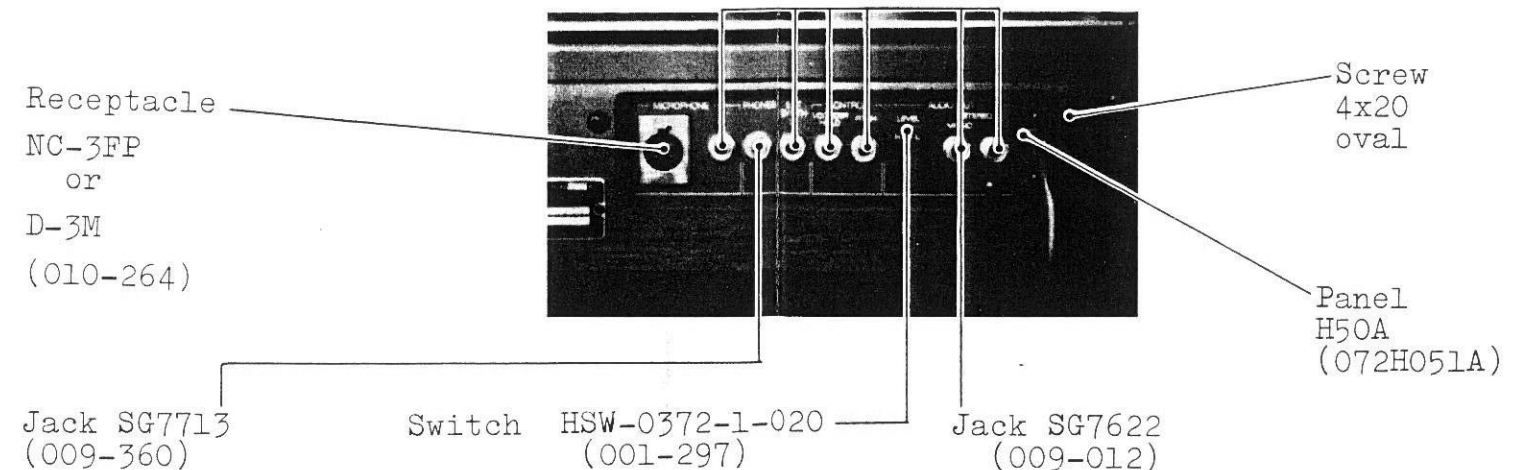

● SPECIFICATIONS

Keyboard (49 keys, C-C)

STRINGS Section

- STRINGS Tablets
- UPPER Strings 4'
- LOWER Strings 4'
- ATTACK control
- TONE control

RELEASE Control

(for strings, human voice, vocoder)

HUMAN VOICE Section

- VOICE Tablets
- FEMALE 4' } UPPER
- MALE 8' }
- MALE 4' } LOWER
- MALE 8' }
- ENSEMBLE Tablet
- ATTACK Time control

VOCODER Section

- VOCODER Tablets
- UPPER 8'
- LOWER 8'
- ENSEMBLE Tablet
- TONE Control
- MIC LEVEL Control
- Mic Level Indicator

Vibrato (Human voice, vocoder)

- DEPTH Control
- DELAY TIME Control
- RATE Control

BALANCE Section

- STRINGS Level
- HUMAN VOICE Level
- DIRECT MIC Level

EXTERNAL SYNTHESIZER Section

- INPUT LEVEL Control
- Input Level Indicator

HEADPHONE VOLUME Control

MASTER VOLUME Control

TUNING Control (± 50 cents)

PITCH SHIFT Section

- PITCH SHIFT Slider
- PITCH SET Control (more than one octave)
- TIME Control
- PITCH MODE Switch
- AUTO; OFF (EXT CONT); MANUAL

POWER Switch with indicator

CONNECTORS (1/4" phone jacks except as noted)

- AUDIO OUTPUTS
- MONO, STEREO
- OUTPUT LEVEL Switch
- H: 0dBm, 6.3kΩ
- M: -15dBm, 8.6kΩ
- L: -30dBm, 2.2kΩ
- (0dBm=0.775V RMS, max. 10V p-p)
- MICROPHONE INPUTS
- Unbalanced (10kΩ)
- Balanced (XLR connector)
- HEADPHONE OUTPUT (Stereo)
- EXTERNAL SYNTHESIZER INPUT
- EXTERNAL CONTROL INPUTS (for DP-2 Pedal Switch)

- VOCODER HOLD
- PITCH SHIFT

Power Consumption: 24W

Dimensions: 905(w) x 370(d) x 145(h)mm

Weight: 14kg

Accessories: 2.5meter connection cord (x2)

DP-2 Pedal Switch

Music Stand

How to fold pages for simultaneous view of Circuit Diagram, PCB Layout and Adjusting Procedure.

For simplicity of circuit analysis, the circuit diagrams of the PC boards and their interconnections are shown on one master drawing.

The drawing below shows how the pages of this manual may be folded in order to see the parts layout diagrams along with its related circuit diagram without having to turn pages.

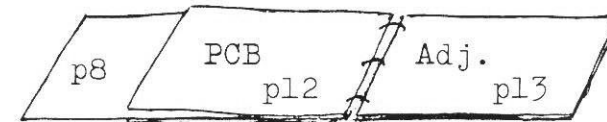

AGH17
HVH56

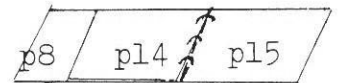

OPH60
JAH59
PSH42/43

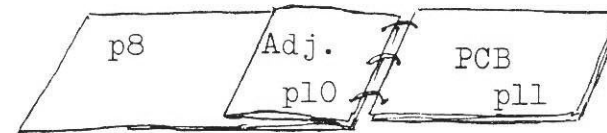

VBH58
FLH16

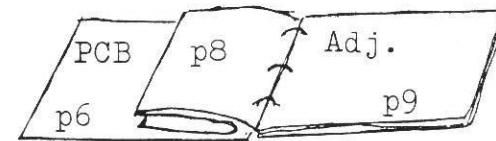

ETH09

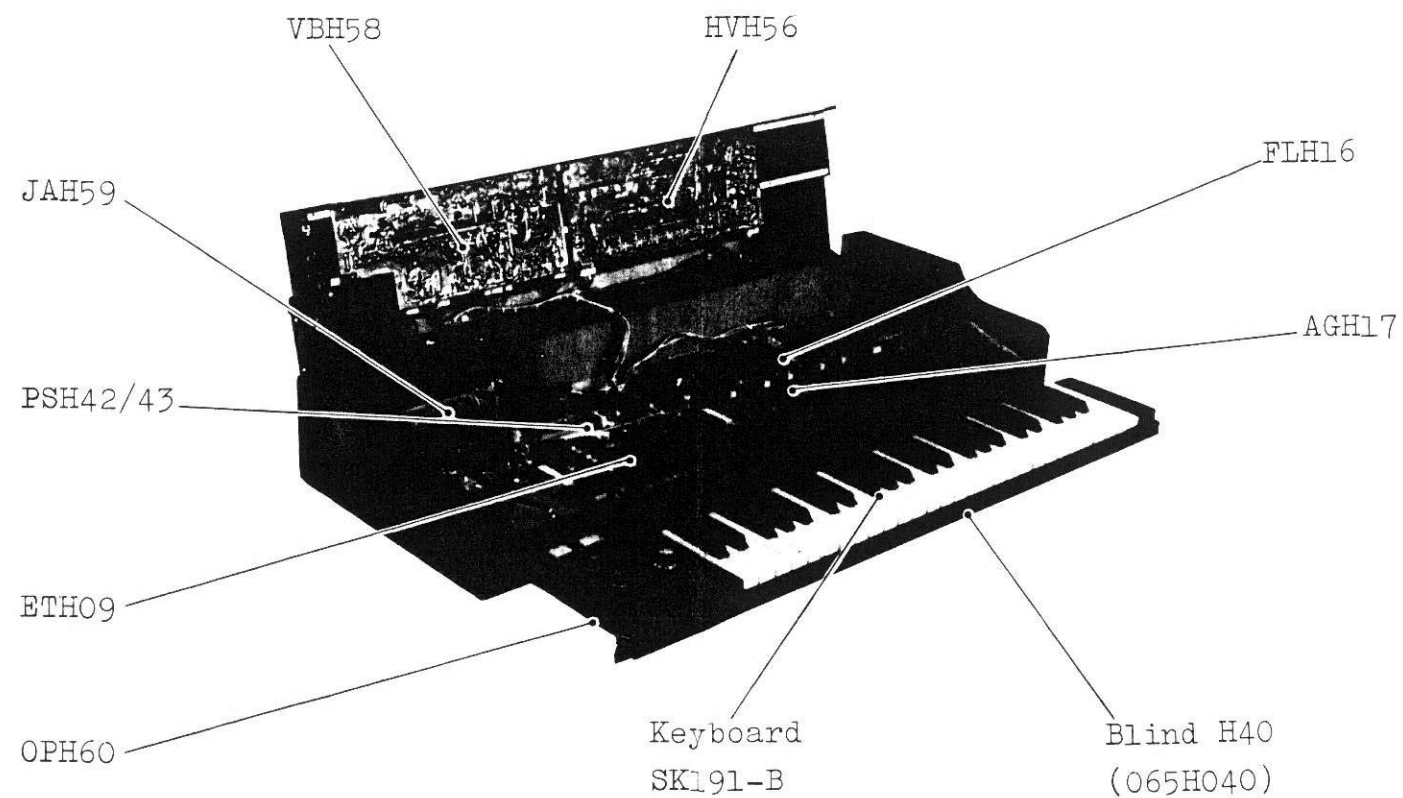

CIRCUIT DESCRIPTION

—General—

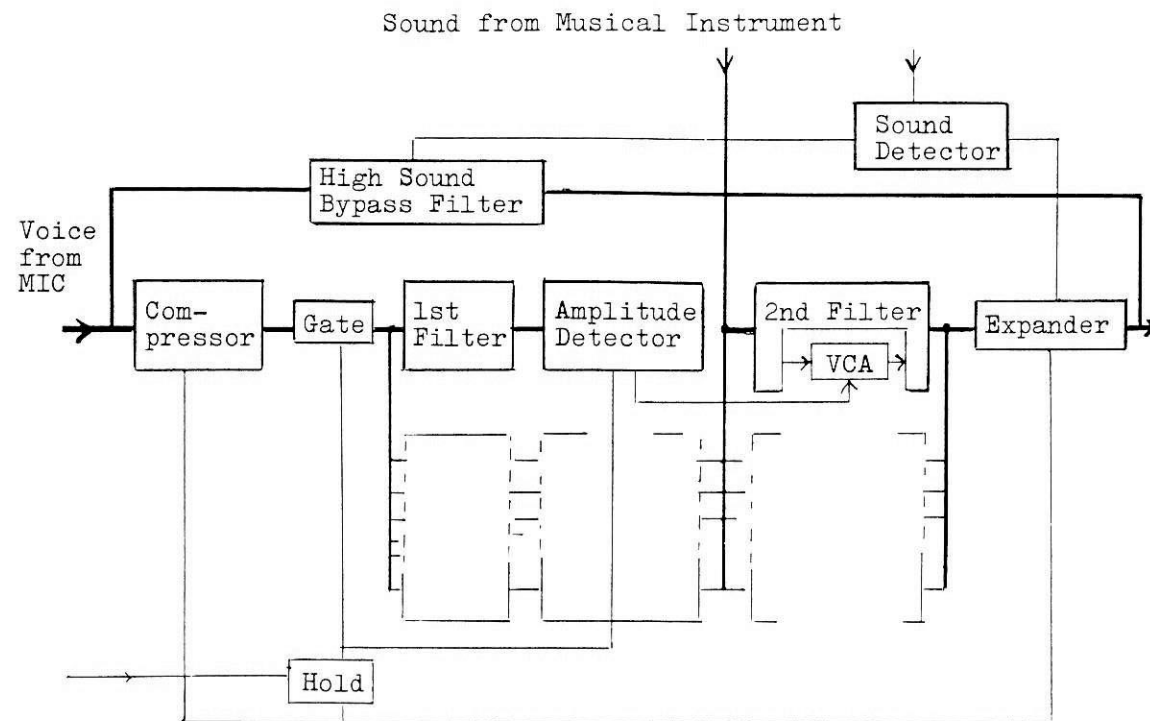

In the Vocoder, the voice signal from a Mic is frequency-analyzed through a group of filters to provide a voice signal frequency spectrum featuring human voice. Then the spectrum is duplicated to another group of musical sound signal filters to obtain functions equivalent to human mouth and throat and thus to simulate human voice with musical sound signals.

Fundamental Vocoder functions are described below according to the Block Diagram shown above.

1. Analyzing (first) Filter and Amplitude Detectors

A Mic input signal is resolved by a group of filters into frequency band components which are amplitude-detected and supplied to the VCAs of the Synthesizer Filter (second filter).

Signals passing through second filters are controlled in volume at VCA by the control signal coming from corresponding frequency band of the first filter.

2. Synthesizer (second) Filter and VCAs

Like the first filter, a musical sound signal being supplied is resolved into frequency spectrum components. Since a musical sound passing through the second group of filters is proportional to the first filter output amplitude, the spectrum of the second filter output is analogous to that of the voice signal. In other words, the second filter output is mixture of the input musical sound signal and the first signal output. Thus, uniform sound signal spectrum would be ideal for reproduction of human voice, but it is no longer of a musical instrument.

3. Componder

The compander is a combination of a compressor and an expander.

The compressor reduces a mic input signals range in amplitude and supplies smaller output signals range than input signals' to the first filter.

On the contrary, the expander, for a given range of amplitude input voltages, produces a larger amplitude range of output voltage. Thus restores the original volume range.

4. High Frequency Voice Signal Bypass Filter (Resonant Filter)

Since musical sounds rarely include high frequency noise components such as "fricative" may be in voice, the second filter has no spectrum to respond to. Furthermore, such a sound, hardly relating to musical intervals, is separated from a mic input signal, passes through this circuit and is recombined with the second filter outputs.

5. Musical Sound Signal Detector

This circuit obstructs the second filter output as long as a musical sound is not supplied to the Vocoder and tells the circuits 3 and 4 whether a musical sound signal is being fed or not.

6. Hold Circuit

This circuit enables Vocoder to hold its output during an interruption in mic signal, e.g. when a singer inspires. The function can also be used for some special effect applications.

During holding, this circuit retains spectrums and volume by holding amplitude detectors output voltages and expander control voltage.

The compressor gain is minimized and the voice gate is turned off so as to keep voice unchanged even though Mic input signal is changing.

CIRCUIT DESCRIPTION

—Detail—

1. AGH-17

1-1 Master VCO

The frequency of this master oscillator is determined by capacitance of D149, variable capacitance diode. The pitch can be shifted in the range of one octave by changing the voltage being applied across D149.

Pitch stability is about ± 15 cents at the working temperatures 0° to $+40^{\circ}\text{C}$ ($+32^{\circ}$ to $+104^{\circ}\text{F}$).

After the VCO components or the components affecting DC supply voltages are replaced or repaired, frequency check or retuning may be required.

When the components are soldered, allow them to return to a normal temperature (ambient temperature).

1-2. Tone Dividers, Tone Gates

The Master VCO output is divided into one half by IC7 and furthermore divided into twelve top octave notes by IC8. The lower octaves for each of the 12 notes are provided by frequency divider circuits IC1-IC6, and supplied to the base of corresponding transistor chopper, Q2, Q3, --- (hereafter plural same circuits are represented by the uppermost circuit in the circuit diagram). Q2 in this case acts as a Tone Gate.

1-3. Key Trigger Detector

This detector, composed of Q153, Q154 and Q157, detects the bus bar current variation caused by the on/off operation of the key contacts to generate gate signals.

1-4. Release Control

This circuit, composed of Q155 and Q156, controls the discharge of the capacitor C1, generating an envelope for the tone gate according to gate signals and signals from the HVH-56 Release Envelope Generator. When a key is pressed, a ground is placed at Q155 collector for approx. 50ms to completely discharge charges which may have remained in C1, C5, C9, --- due to previous key pressing and then, Q155 and Q156 develop a voltage envelope according to a signal from the Envelope generator.

2. HVH-56

2-1. Release Envelope Generator

The circuit consists of Q11, Q12 and Q13. While key(s) is depressed, connection terminal J1-1 on HVH-56 is held at a voltage determined by RELEASE knob, and when the key is released, the voltage decays with an envelope shaped by the circuit constant, causing the Release Control on the AGH-17 to discharge C1 through D1.

3. FLH-16

3-1. Comander

This comander system is composed of the Mic Input Detector IC2 (full-wave rectifier), Peak Detector IC1, V-I converters IC3, Q5, IC8, Q12, Compressor IC3, IC4 and Expander IC8, IC9.

One half (positive, negative) of compressor output is 10V maximum.

Gains of the Expander and Compressor are controlled by voltages from IC1, whose directions are opposite to each other, that is, when the amplitude of one circuit increases, that of the other circuit decreases.

When the tablets "Vocoder- UPPER, LOWER" are off and the EXT. SYNTH input is less than a certain level, the Expander output remains at the minimum since the EXP. control Q13 turns on.

3-2. Analyzing Filter

Ten BPFs with a high Q, composed of ICs (e.g. IC10 and IC15) and associated resistors and capacitors, divide an input signal among them covering 170Hz-7kHz, and let particular band frequency to pass. A Mic signal from the compressor is preemphasized, passes through the BPFs corresponding to the spectrum and goes to D1 where the peak amplitude is detected, is smoothed and supplied to the VCA in the next stage filter (Synthesizer Filter).

3-3. Vocoder Hold

This circuit composed of Q1, Q2, Q3 and Q4.

When the Hold jack circuit opens, and 50ms later, the Q4 output increases in the positive-going direction to turn on the gate Q6 and to shunt IC10 input to the ground. On the other hand, a signal supplied through D17 turns off the FET Switch IC35 connected to R7 and increases discharging time constant, thus, the charging voltage detected by D1 is held for 2-3 sec.

3-4. Synthesizer Filter, VCA

Like the previously mentioned analyzing filters, each input signal spectrum component passes thru a corresponding BPF and goes to the VCA, IC38 where its gain is controlled according to the voltage from the previous stage amplitude detector.

The ratio of on/off switching time (signal passing time) of the FET gate IC38 is determined by the Q14 collector output duty ratio which is in turn determined by the triangular wave from IC6 and the TP-30D DC level being superimposed on the triangular wave.

While the mic input is not fed, the bias circuit IC7 sets the Q14 emitter voltage so that Q14 keeps on, and holds IC38 at off.

Since the IC38 on/off switching cycle is sufficiently faster than those of musical signals, the filter gain is proportional to the on/off time ratio.

Pulse-like signals from the gate (VCA) are smoothed through a BPF and sent to the expander.

Overall frequency response of the Synthesizer filter is equal to de-emphasized characteristics: higher the frequency, the larger value R21 has.

3-5. Expander

Like the compressor, the gain of expander IC8 and IC9 is controlled by the voltage from IC1, whose direction is opposite to that for the compressor.

4. VBH-58

4-1. High Consonant Circuit

This HPF allows only high-frequency components of the signal from the Mic amp to pass so as to compensate for high-frequency ranges incapable of reproduction by the Vocoder circuits.

Like the FLH-16 expander output on/off circuit, the Gate Switch, Q4 is provided not to output signals from the HPF while the Vocoder circuit operating conditions are not readily prepared.

5. OPH-60

This circuit has basically the same configuration with the OPH-29 in the RS-505 Roland String Ensemble. See the diagram on page 11 of the RS-505 Service Notes for easier understanding.

5-1. AUTO

The Envelope Generator, Q1 and Q3 output voltage, when triggered by the Gate signals, increases up to the voltage set by the PITCH SET and then decays.

Level Sustain and Decay time are made longer as the TIME knob being set toward LONG.

5-2. OFF (EXTERNAL CONT)

When the EXT PITCH jack connection is not made, settings for the TIME, PITCH SET, and NORMAL-DOWN are invalid.

When the PITCH jack is open, the Q6 collector holds the voltage according to the PITCH SET setting and when the jack is closed, the voltage varies in accordance with the TIME setting.

5-3. MANUAL

In this mode, the trigger and TIME are independent of the GATE. The maximum shift voltage is determined by the PITCH SHIFT. Thus, manual range variation is possible within the range by controlling the knob.

6. JAH-59

6-1. MIC HEAD AMP

The gain of this circuit is 20dB.

Use ETH09B (151-009B) for replacement (no components on foil side)

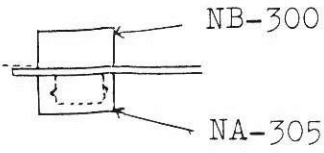
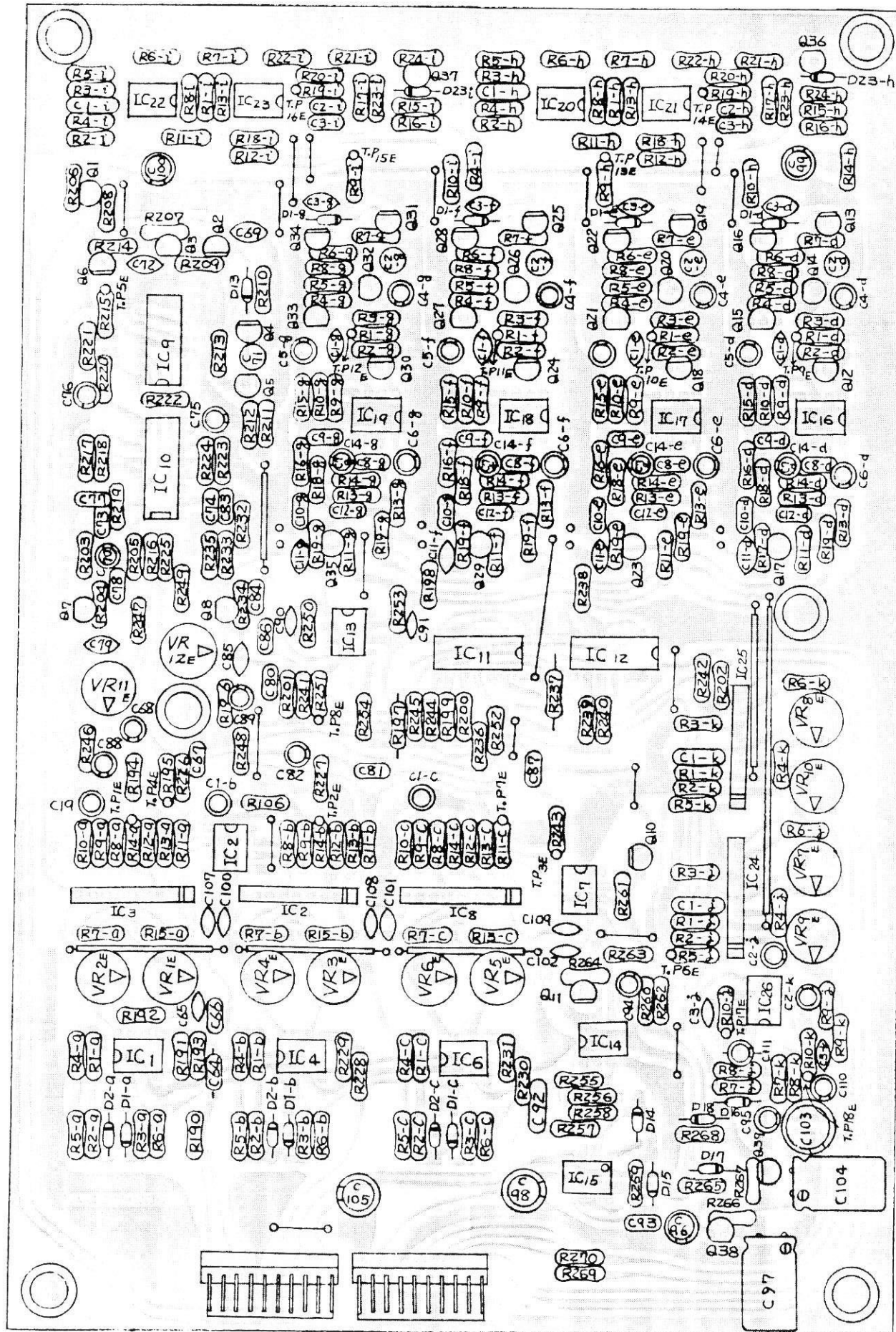

- | | | | |
|--|-----------------------|--|--------------|
| | 2SA-1015 | | MYLAR |
| | C-381 | | CERAMIC |
| | C-752 | | ELECTROLYTIC |
| | C-1815 | | NON POLAR |
| | K-30A | | TANTALUM |
| | 1S-2473 | | TRIMMER |
| | CARBON, 1/4W, ±5% | | JUMPER |
| | METAL FILM, 1/4W, ±1% | | |
| | SOLID, 1/2W, ±10% | | |

ETH09A Components on the foil side
(Top View)

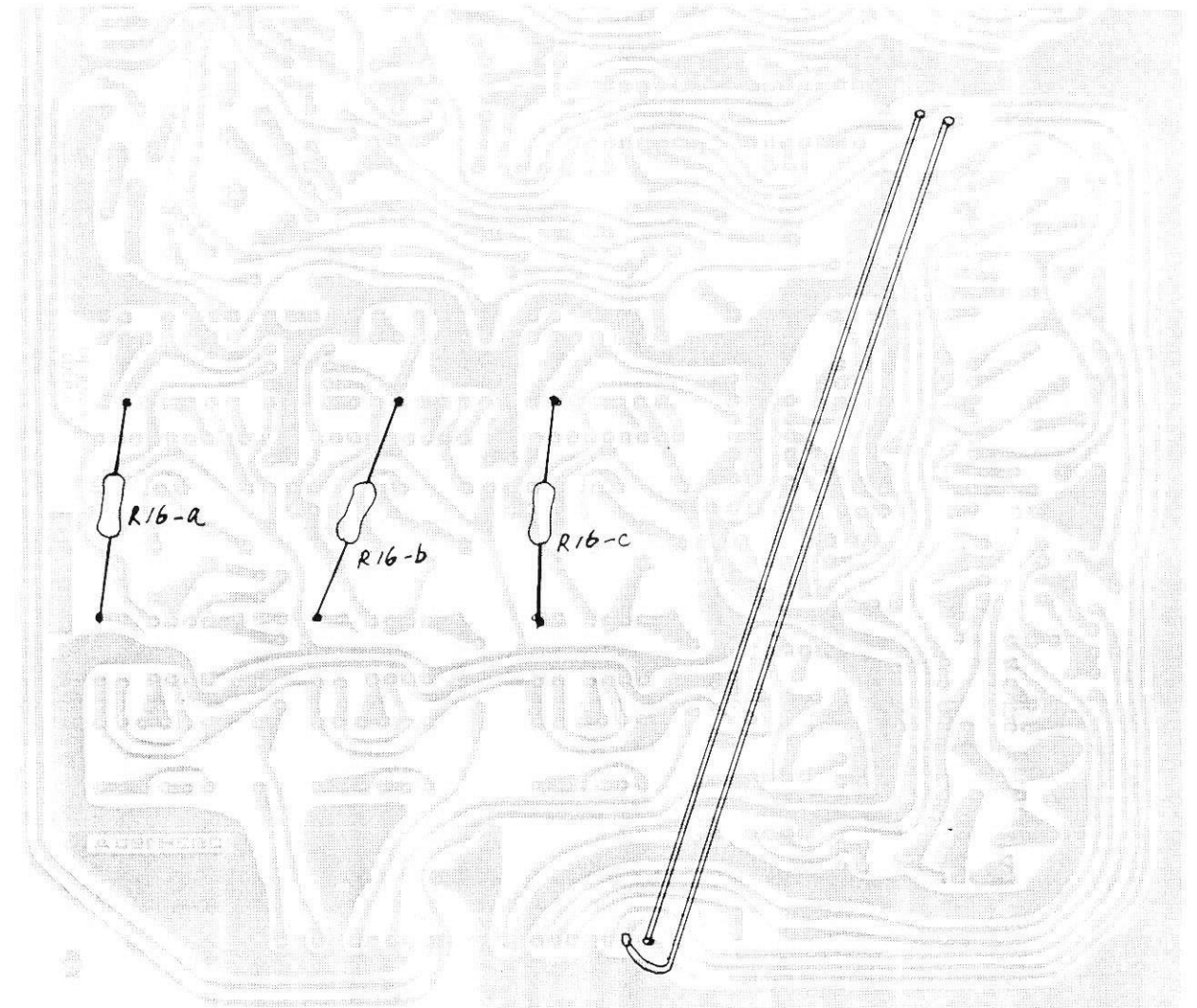

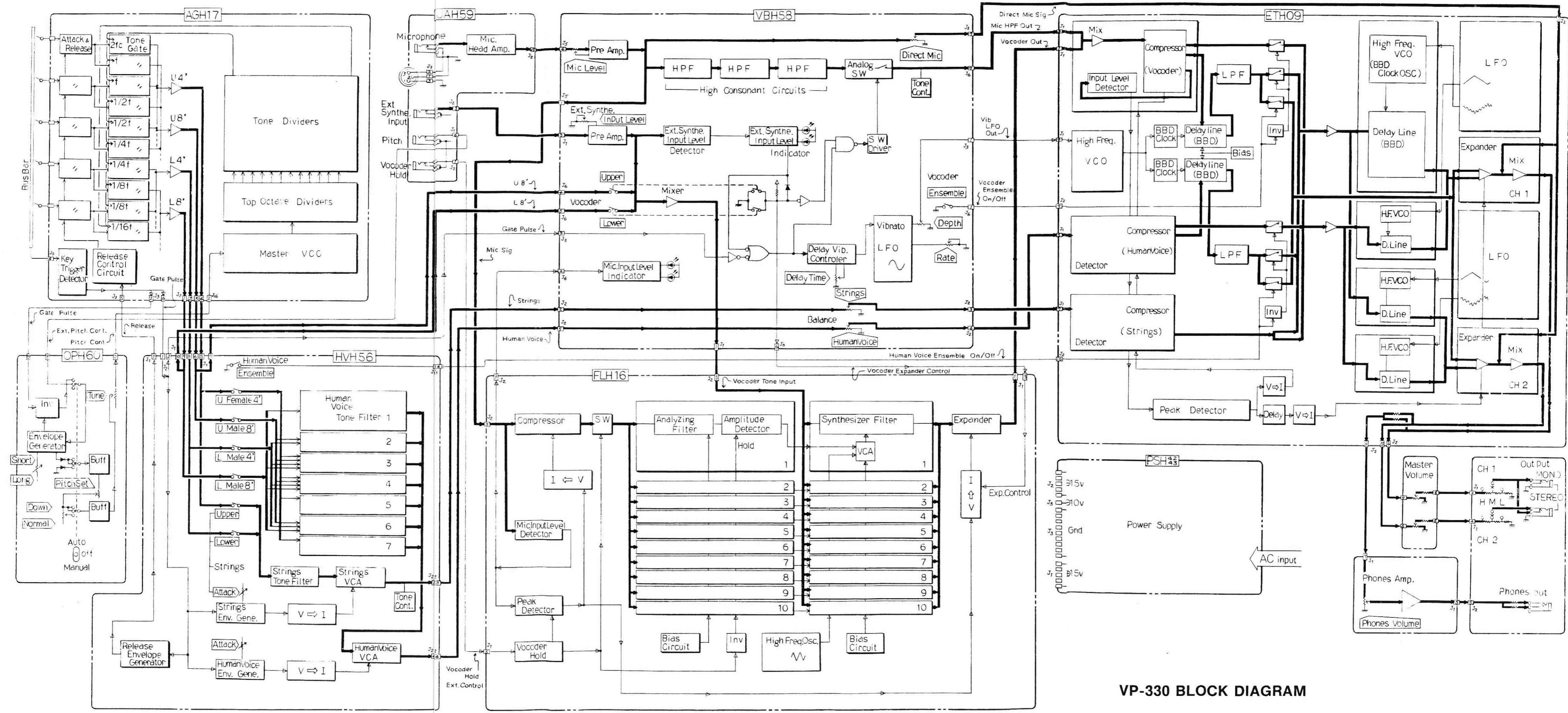

VP-330 BLOCK DIAGRAM

VP-330 OVERALL CIRCUIT DIAGRAM

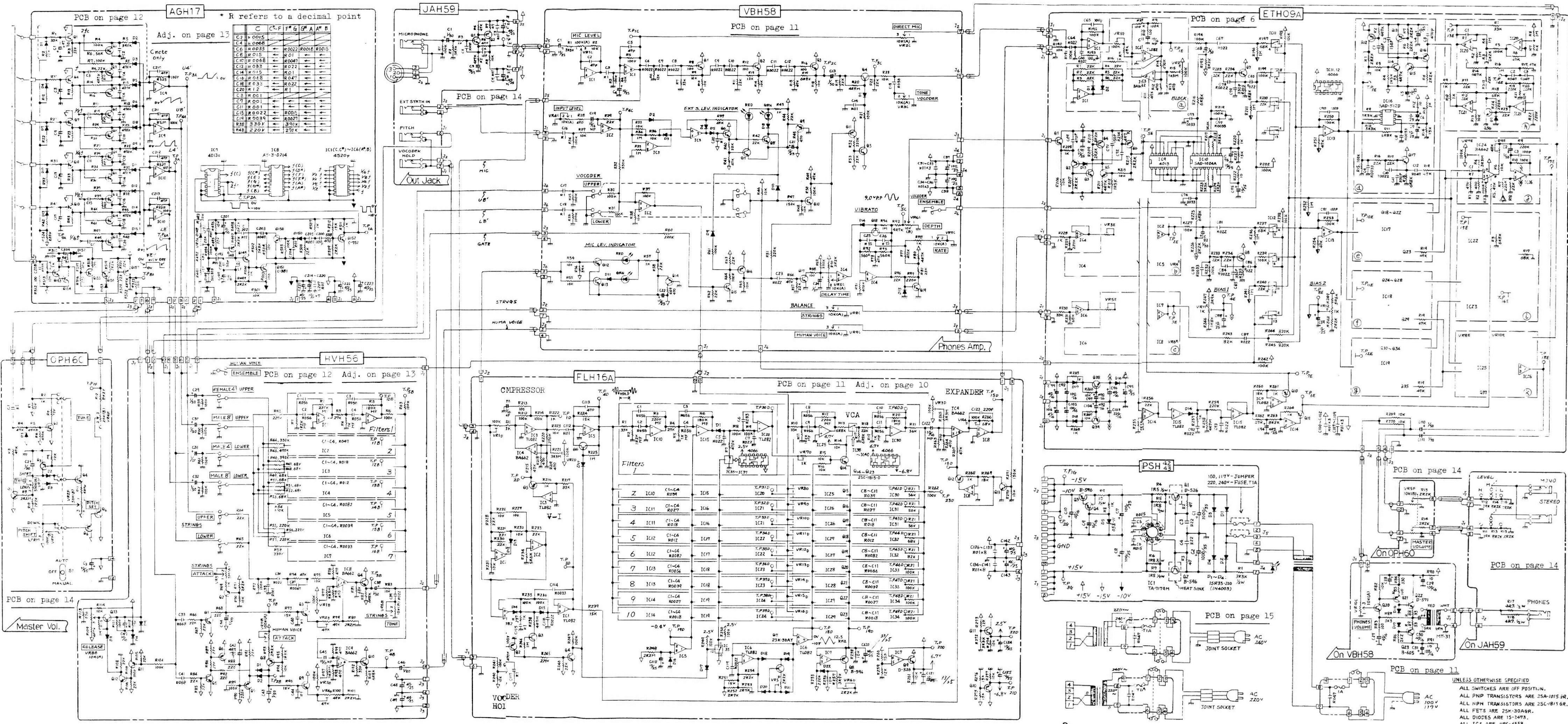

UNLESS OTHERWISE SPECIFIED:
 ALL SWITCHES ARE OFF POSITION.
 ALL PNP TRANSISTORS ARE 2SA-1015 GR.
 ALL NPN TRANSISTORS ARE 2SC-1815 GR.
 ALL FETS ARE 2SK-30A6R.
 ALL DIODES ARE 1N-347S.
 ALL ICs ARE MPC-4558.

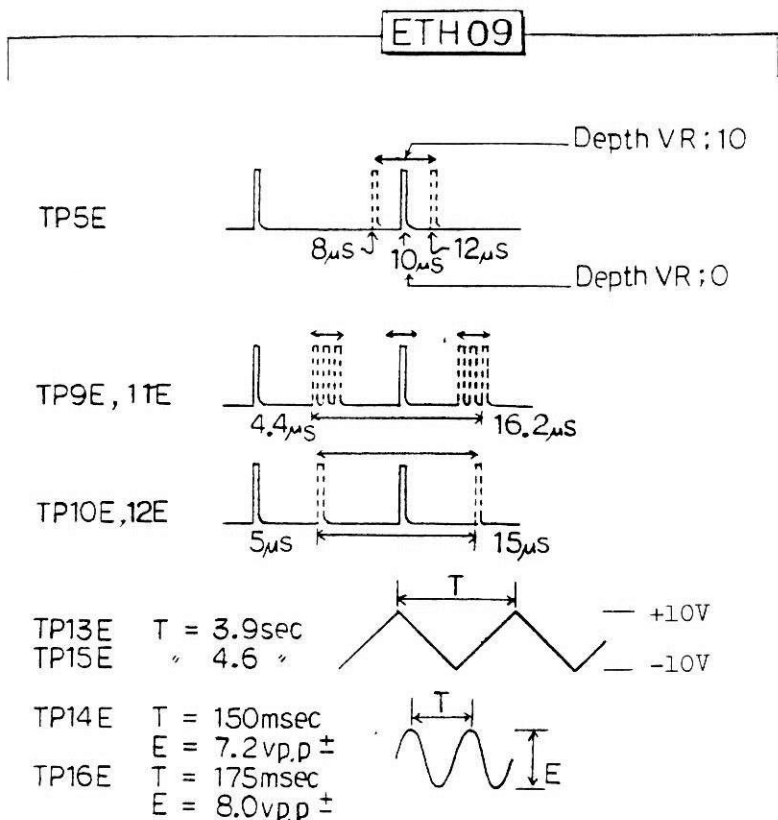

VOCODER COMPRESSOR (IC2, IC3)

1. DC BALANCE

While applying a ground to TP-7E intermittently (touching one end of a lead to chassis with the other end clipped at TP-7E), adjust VR 2E for minimum DC level variation.

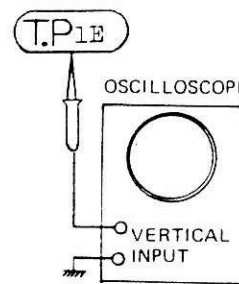

2. GAIN

Feed a signal 1kHz, sine 5Vpp into J1-3.

Adjust VR 1E for 18Vpp at TP-1E.

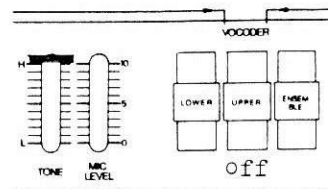

STRINGS COMPRESSOR (IC7, IC8)

1. DC BALANCE

While applying a ground to TP-7E intermittently (touching one end of a lead to chassis with the other end clipped at TP-7E), adjust VR 6E for minimum DC level variation.

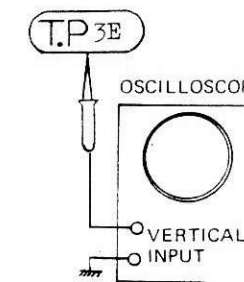

2. GAIN

Feed a signal 1kHz, sine, 15Vpp into J1-7.

Adjust VR 5E for 18Vpp at TP-3E.

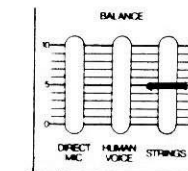

MIXING AMP

- CH-1 EXPANDER (IC24, IC26) -
- CH-2 EXPANDER (IC25, IC26) -

1. DC BALANCE

While applying a ground to TP-6E intermittently (touching one end of a lead to chassis with the other end clipped at TP-6E),

- a. adjust VR 7E for minimum DC level variation at TP-17E,
- b. adjust VR 8E for minimum DC level variation at TP-18E.

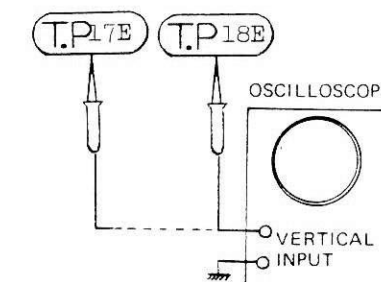

2. GAIN

Feed a signal 1kHz, sine 10Vpp into J1-5.

- a. adjust VR 9E for 5Vpp at TP-17E,
- b. adjust VR 10E for 5Vpp at TP-18E.

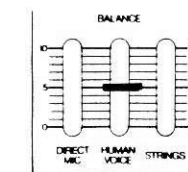

ADJUSTMENT

BBD (IC10)

1. BIAS (VIBRATO)

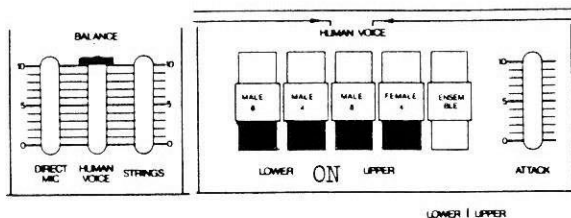
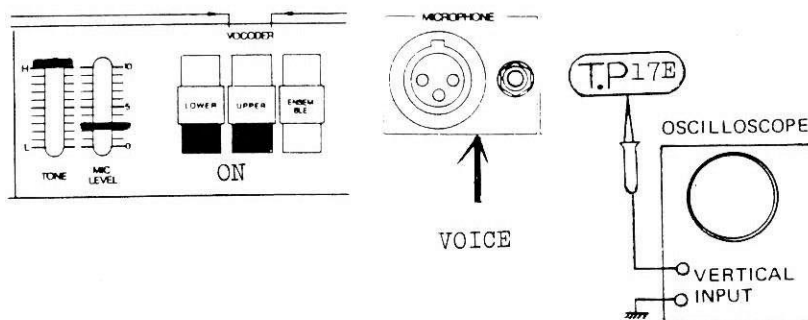

The purpose of this adjustment is to set BBD operating point at its center. First, make an adjustment in either mode; VOCODER or HUMAN VOICE, then, check waveform in the other mode for saturation.

1. DC BALANCE

While applying a ground to TP-7E intermittently (touching one end of a lead to chassis with the other end clipped at TP-7E), adjust VR 4E for minimum DC level variation.

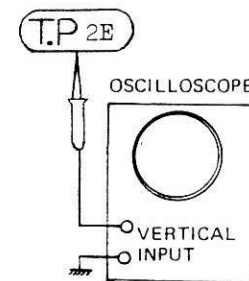

2. GAIN

Feed a signal 1kHz, sine 10Vpp into J1-5.

Adjust VR 3E for 18Vpp at TP-2E.

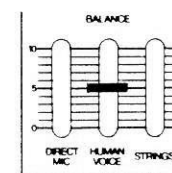

While depressing many keys, adjust VR 11E so that both positive and negative peaks are distortion free, or if flattened, to the same degree or symmetrically. (depends on mic level and number of keys played)

This adjustment can be done by listening to the sound through a monitor speaker, but input to the BBD must be adjusted to the level in which the sound is more or less than saturation.

If operating point is out of the center, it sounds as it were coming from torn speaker.

2. BIAS (ENSEMBLE)

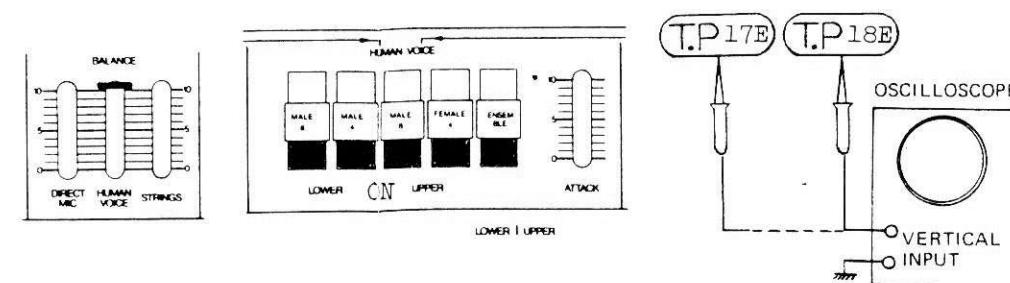

Follow the procedure described in step 1 (VIBRATO), adjusting trimmer here is VR 12E.

FLH16 ADJUSTMENT

FLH16 and VR BOARD 052H209

Serial number up to 830299

Use FLH16A for replacement.
Being included on FLH16A, the components on the VR Board are not necessary after replacement.

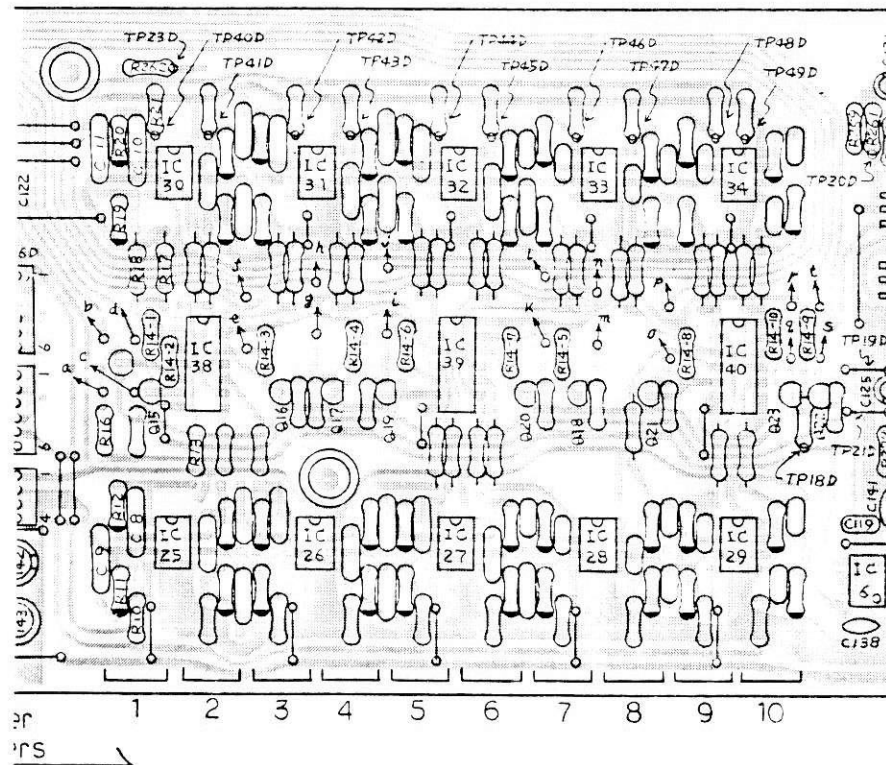
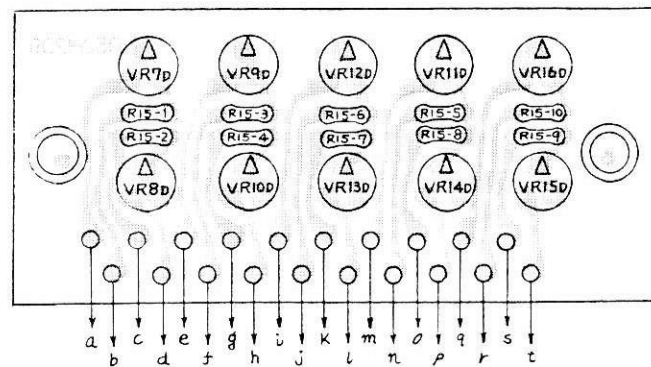

COMPRESSORS (IC3, IC4)

1. DC BALANCE (No signal)

Set VR 2D at center of its travel range. While applying ground intermitently to TP-2D (touching one end of a lead to chassis with the other end clipped at TP-1D), adjust VR 2D for minimum DC level variation.

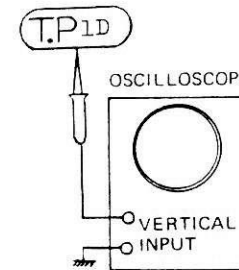

2. GAIN

Apply signal into MIC IN. Adjust VR 1D for 20Vpp at TP-1D.

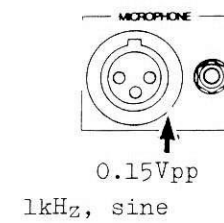

EXPANDERS (IC8, IC9)

1. DC BALANCE (No signal)

While applying ground intermitently to TP-16D, adjust VR 3D for minimum DC level variation. (same as in Compressor step 1)

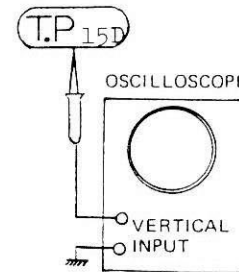

2. GAIN

Apply signal into TP-23. Adjust VR 4D for 12Vpp at TP-15D.

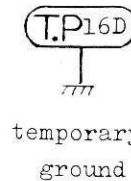
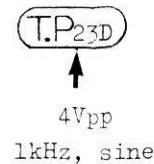

FILTER VCA

1. TRIANGLE WAVEFORM

Adjust VR 5D for 80us/cycle

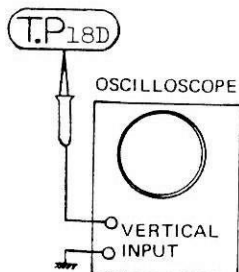
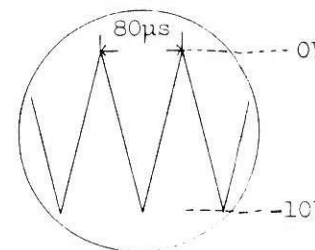

2. BIAS

- VCA TOTAL CUT-OFF -
- VCA INDIVIDUAL CUT-OFF -

Replacing even one of following components causes affected filter's bias to be re-adjusted.

IC15-IC24, D1, R15-16, Q14-Q23.

Allow them to dissipate heat for few minutes before making adjustment.

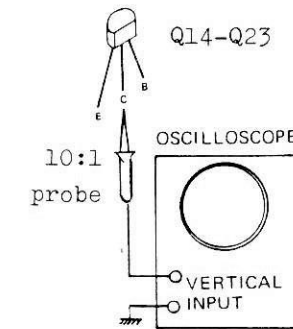

For accurate results, oscilloscope used in this section must be of vertical bandwidth DC to more than 10MHz \pm 3dB with a X10 probe.

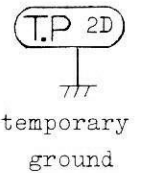

When adjusting all filters, begin with Filter No. 9.

Set VR 15D at around the center of its rotation range.

Adjust VR 6D for figure right.

Proceed to the other filters in any order, referring to the table below, by turning respective VR with probe connected to corresponding Q's collector.

If any VR fails to bring specified value, slightly turn it in reverse direction, then, adjust VR 6D for the value. However, since VR 6D is for the Total adjustment, this will disturb preceding adjustments of this section and all the VRs have been set must be re-adjusted.

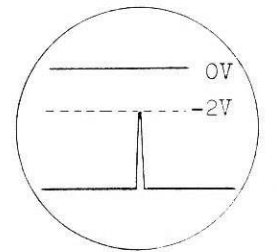

Filter No.	1	2	3	4	5	6	7	8	9	10
Transistor	Q14	Q15	Q16	Q17	Q18	Q19	Q20	Q21	Q22	Q23
Value										
Trimmer	VR7	VR8	VR9	VR10	VR11	VR12	VR13	VR14	VR15	VR16
Center Frequency (Hz)	200	280	400	600	900	1.3k	2k	2.8k	4k	6k

VR 6D shifts this level

VBH58(149H058) (Etch mask 052H191) View from Foil side

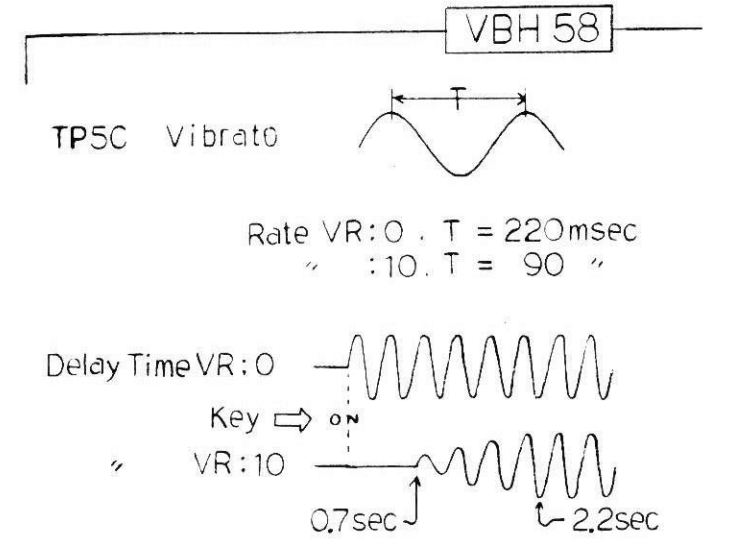
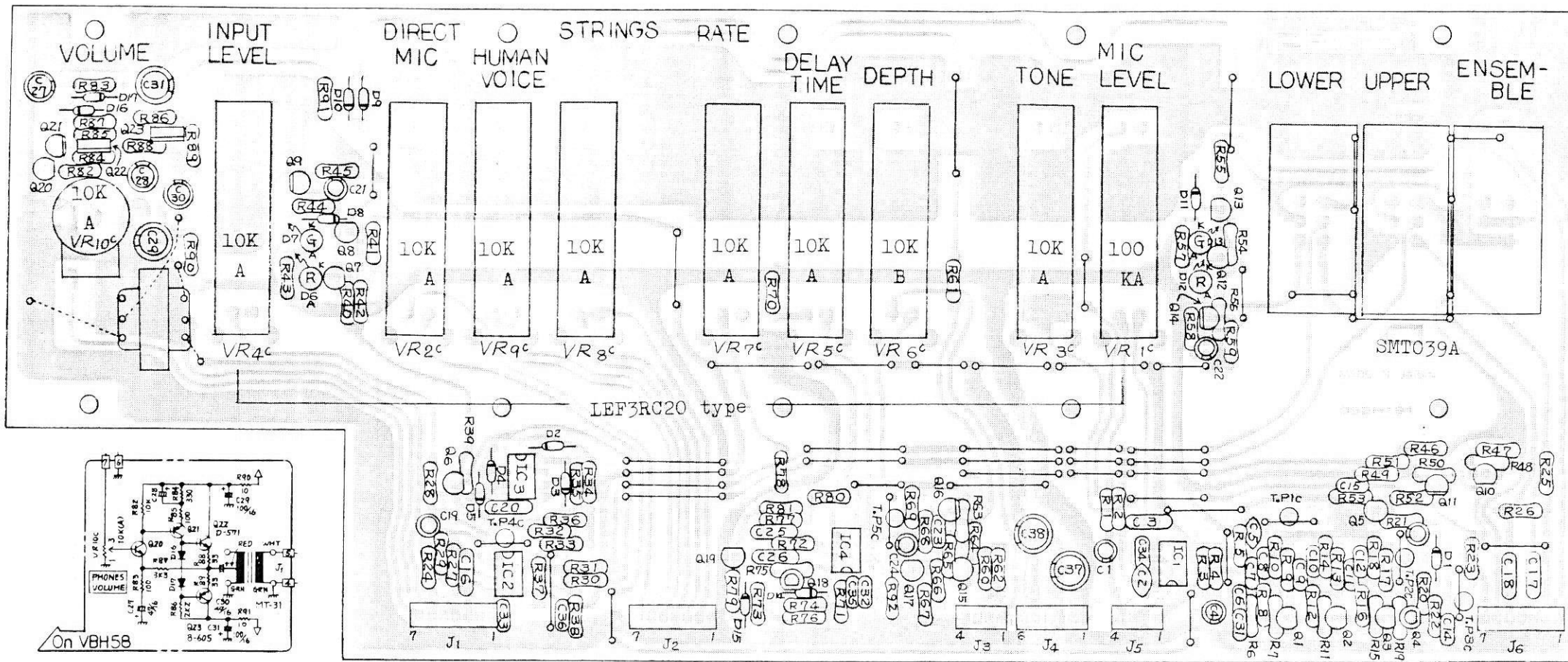

FLH16A (145H016A) (Etch mask 052H189A) Serial No. 840300 and higher .

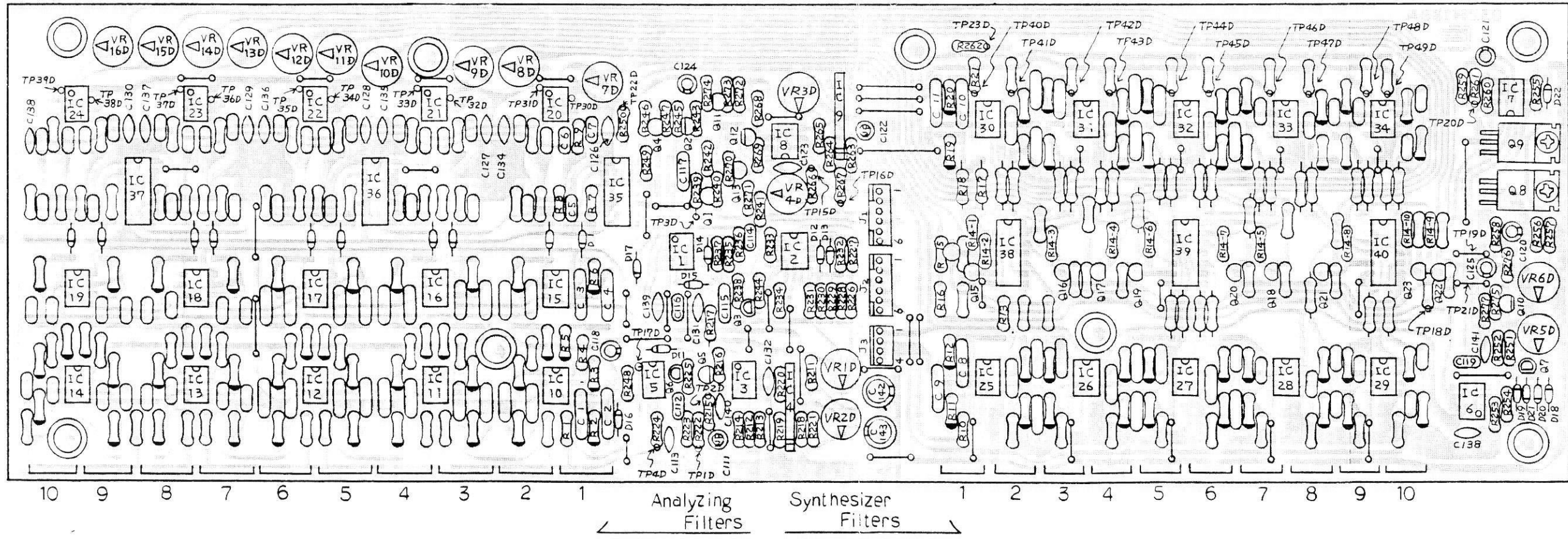
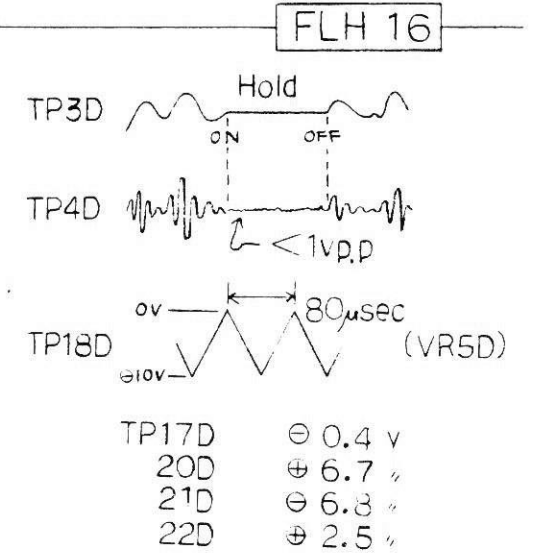

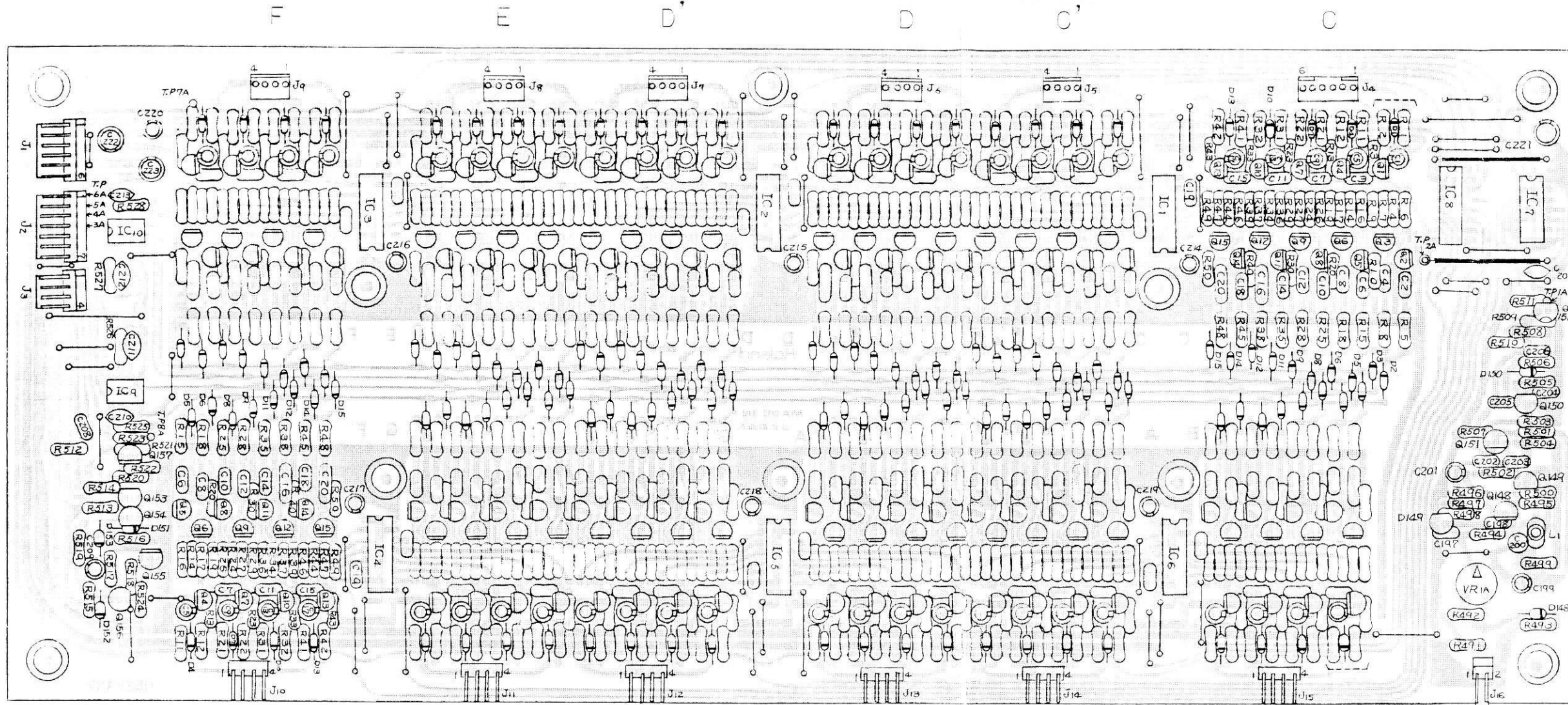

AGH17 (144H017)
(Etch mask 052H187)

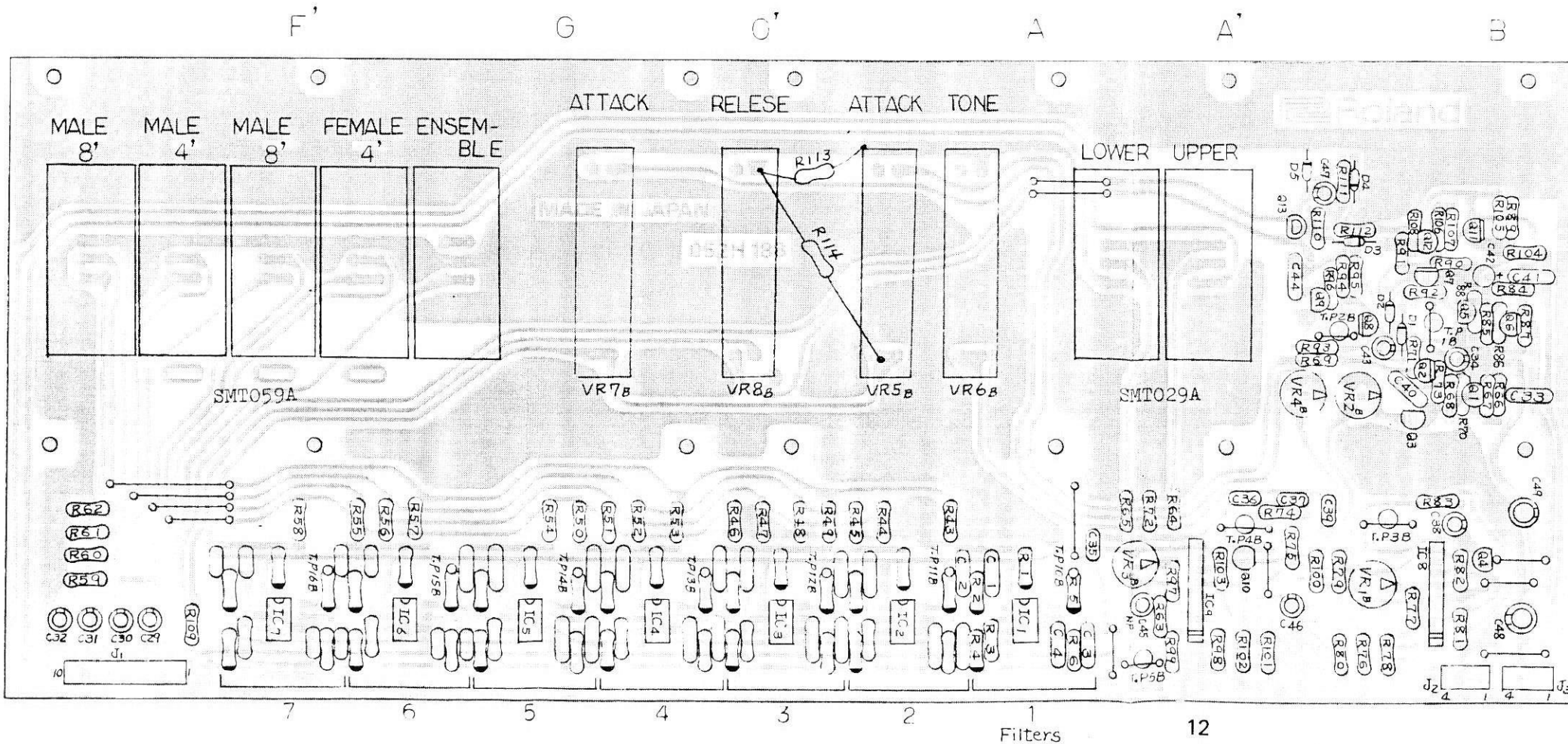

HVH56 (149H056)
(Etch mask 052H188)
View from Foil side

For replacement, HVH56A is available.

CENTER FREQUENCY

Filter	F1	F2	F3	F4	F5	F6	F7
F (Hz)	200	230	600	900	1.3k	2.8k	3.3k

- VR5B 1MA
- VR6B 10KB
- VR7B 100KA
- VR8B 10KA

All LEF3RC20A type

HVH-56 ADJUSTMENT

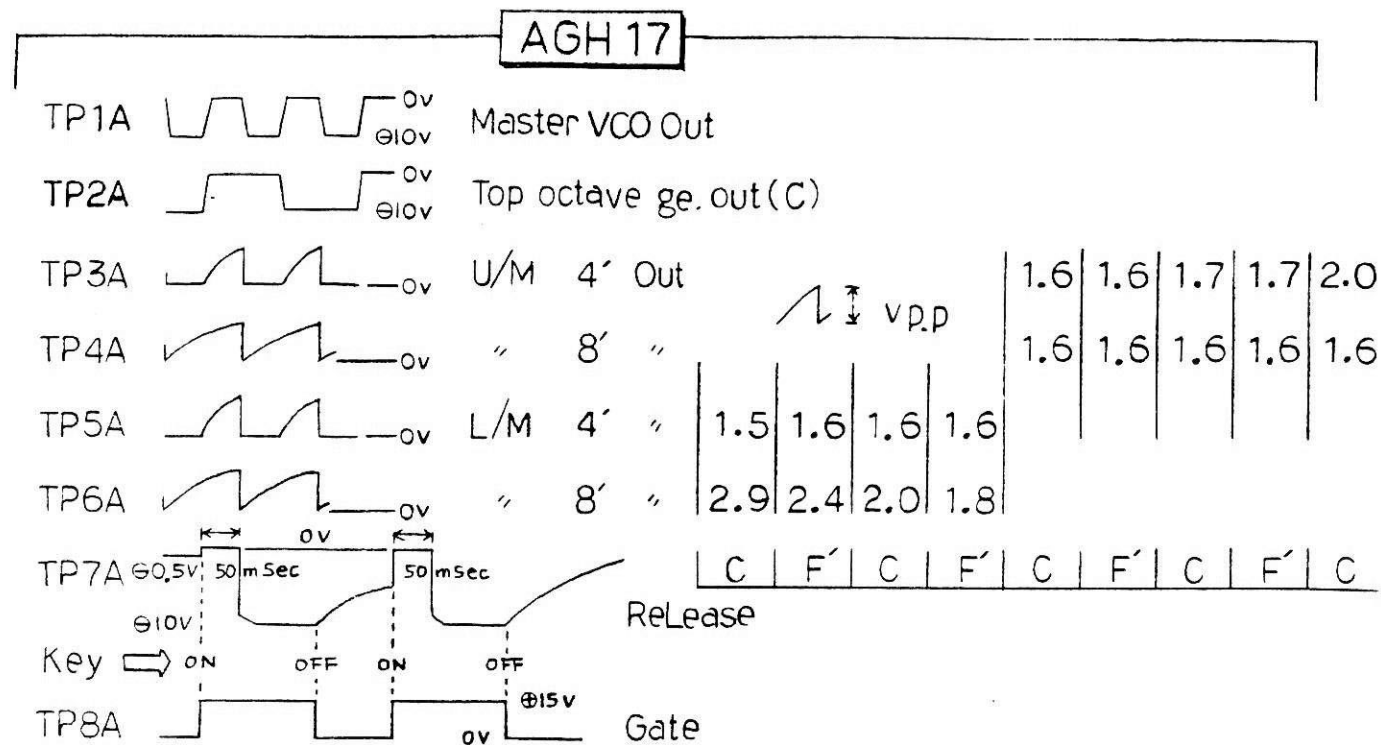

TUNING

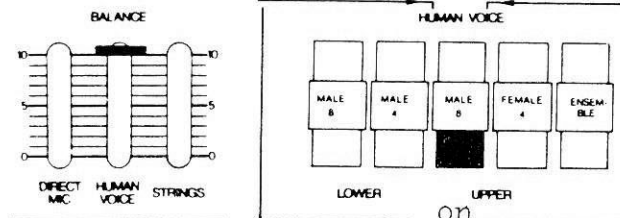
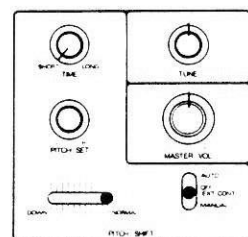

The Master VCO must be retuned after
 1. secondary voltage varies due to modification or repairing around the power supply,
 2. components in the VCO stage are replaced.
 When soldered, allow them to dissipate heat for several minute.
 Set knobs and switches as shown above.
 Adjust VR 1A to produce 442Hz at Output jack with A3 key pressed.

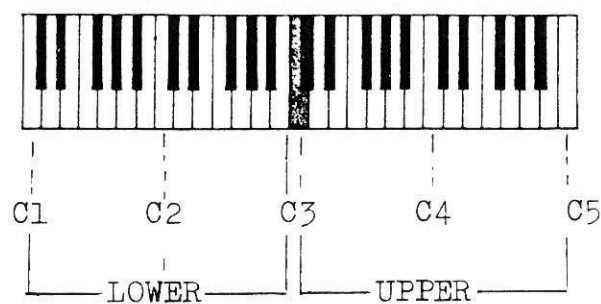

VR 1A can be turned from the bottom through the hole in the cabinet.

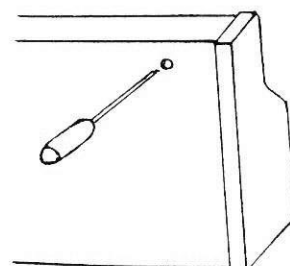

STRINGS VCA (IC 8)

1. STRINGS VCA DC BALANCE

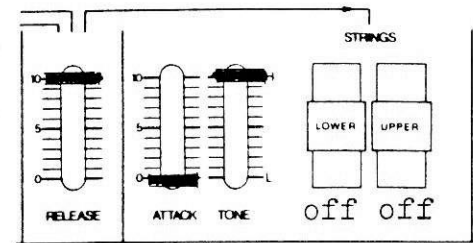

While tapping a key repeatedly, quickly, adjust VR 1B for minimum DC level variation.

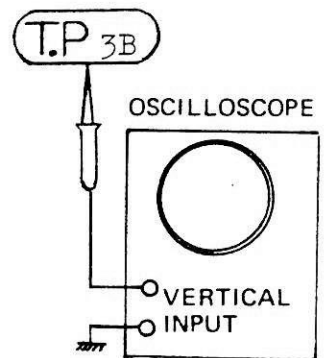
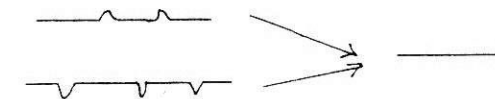

2. STRINGS VCA GAIN

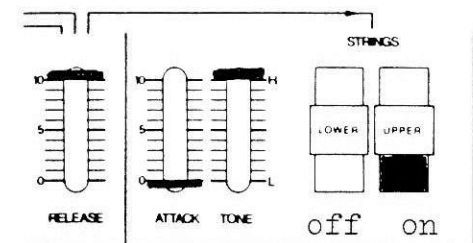

While depressing C3 key, adjust VR 2B for

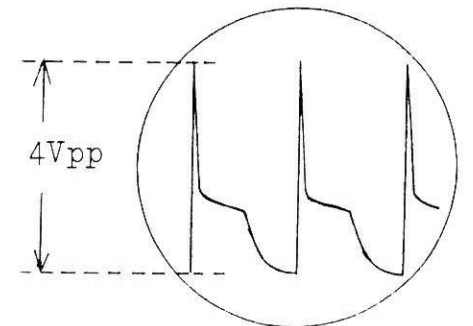

HUMAN VOICE VCA (IC 9)

3. H. VOICE VCA DC BALANCE

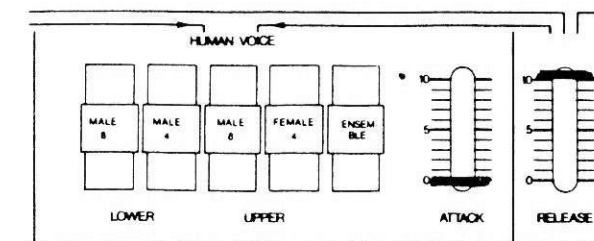

While tapping a key, adjust VR 3B for minimum DC level variation.

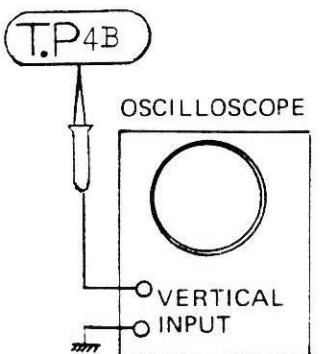

4. H. VOICE VCA GAIN

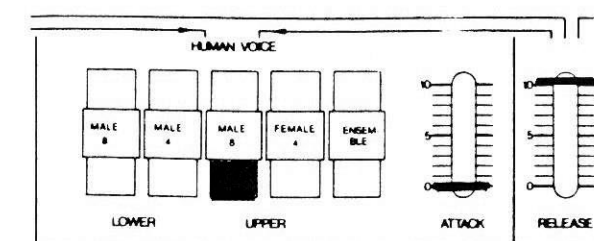

While depressing C3 key, adjust VR 4B for

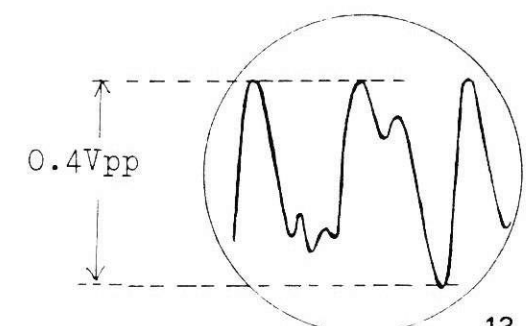

OPH60 (149H060)

(Etch mask 052H129-1)

(View from Foil side)

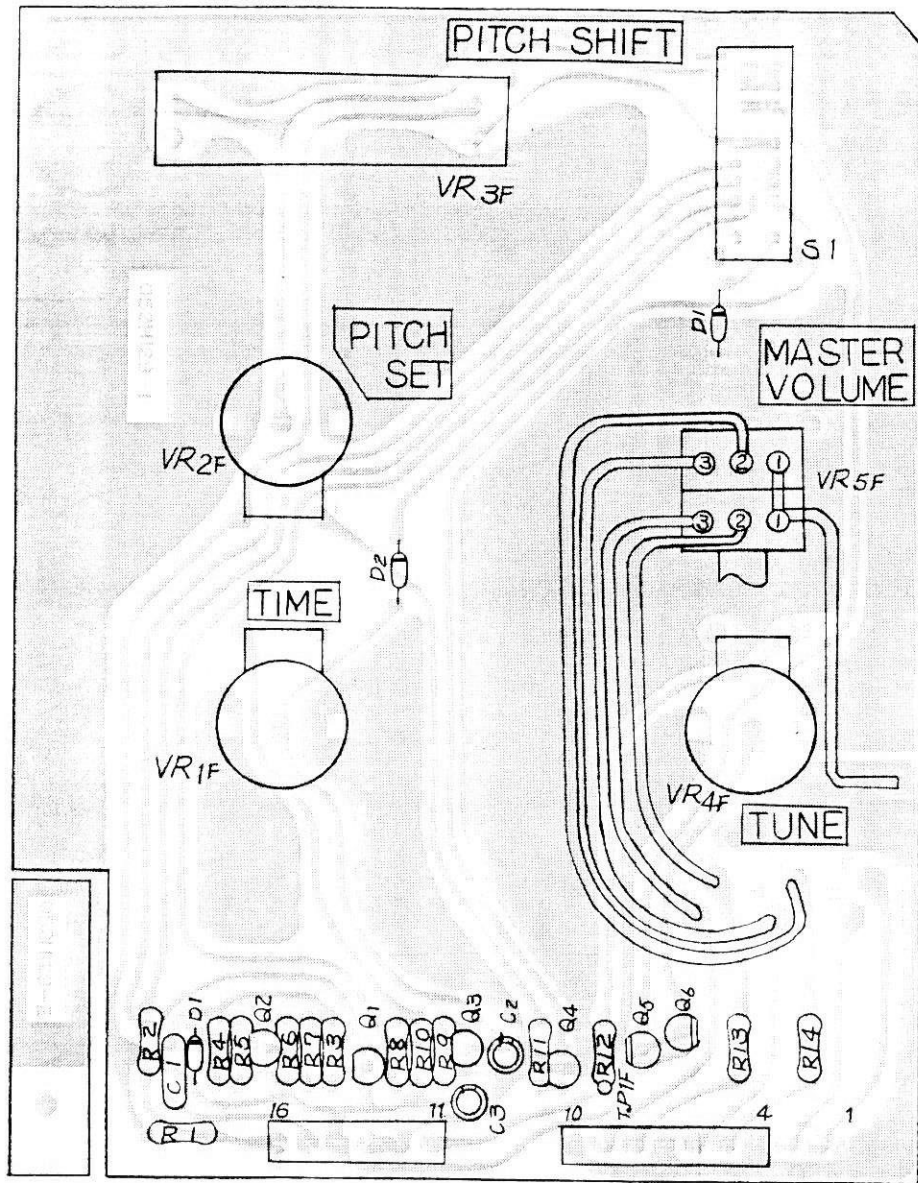

VR1F 500KA
 VR2F 50KB
 VR4F 20KB
 VM60AK30 type

VR3F 100KB
 LEF3RC16B15L

VR5F 10KB x 2
 GM70AK35B14

S1
 SLE643-15P

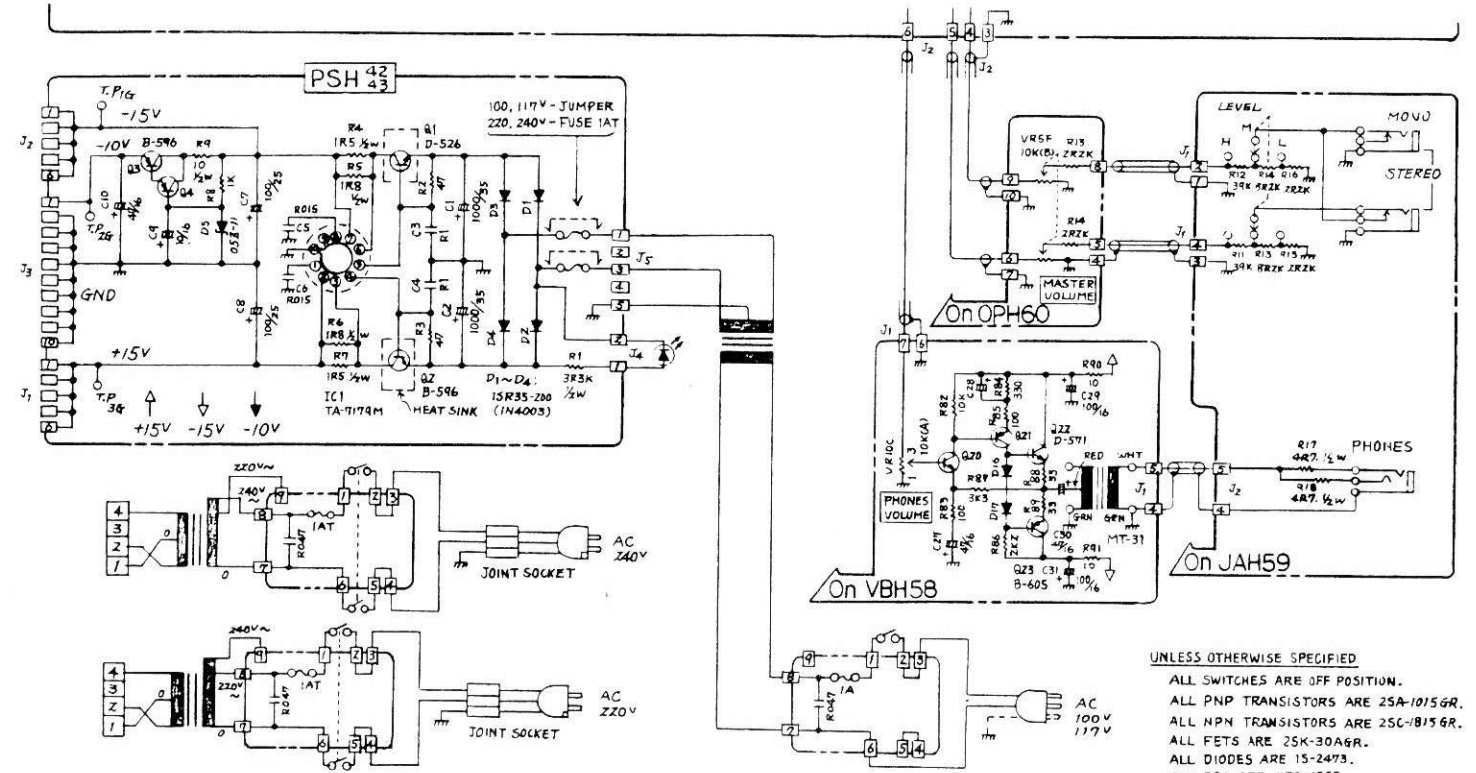

UNLESS OTHERWISE SPECIFIED
 ALL SWITCHES ARE OFF POSITION.
 ALL PNP TRANSISTORS ARE 2SA-1015GR.
 ALL NPN TRANSISTORS ARE 2SC-1815GR.
 ALL FETS ARE 25K-30A6R.
 ALL DIODES ARE 1S-2473.
 ALL ICs ARE μ PC-4558.

JAH59 (149H059)

(Etch mask 052H196)

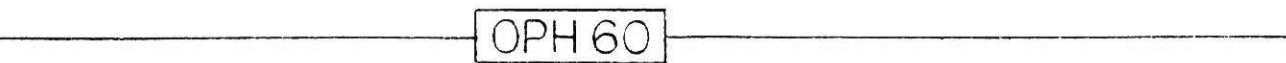
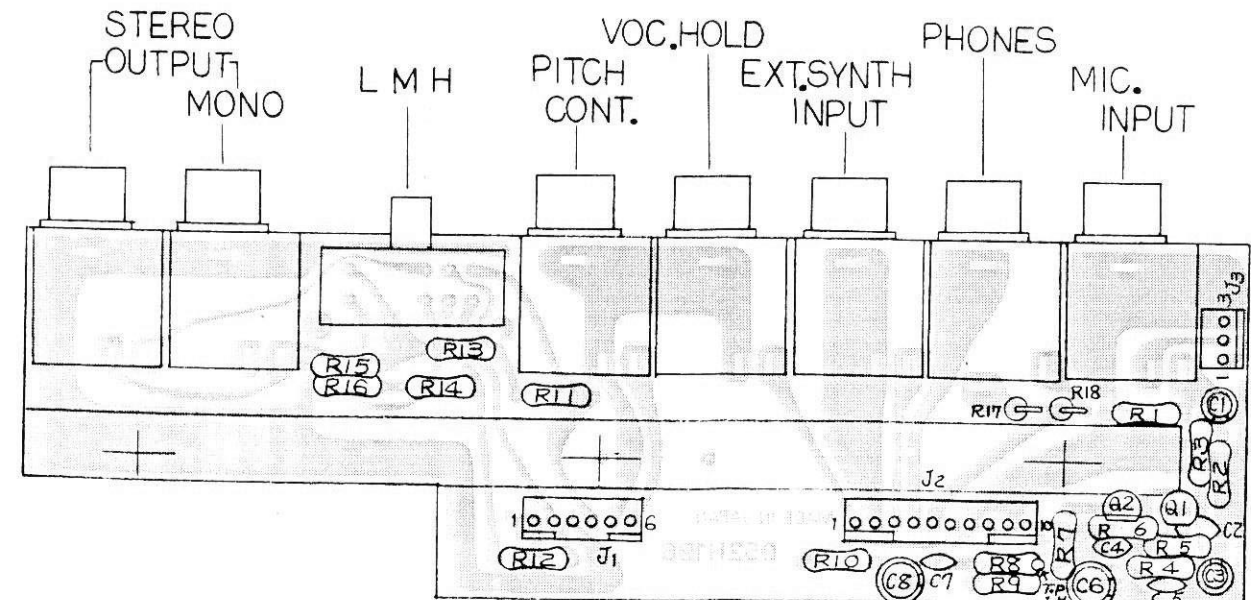

TP1F SW \rightarrow Auto Position
 Pitchset \rightarrow L

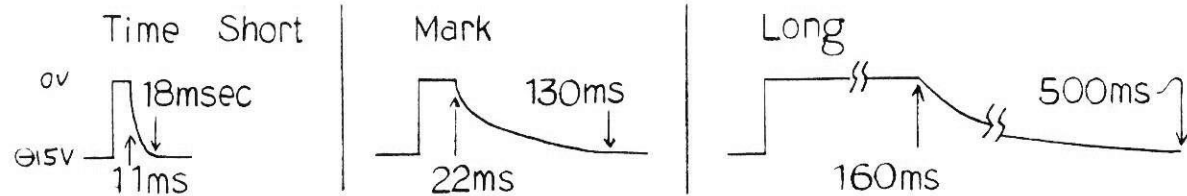

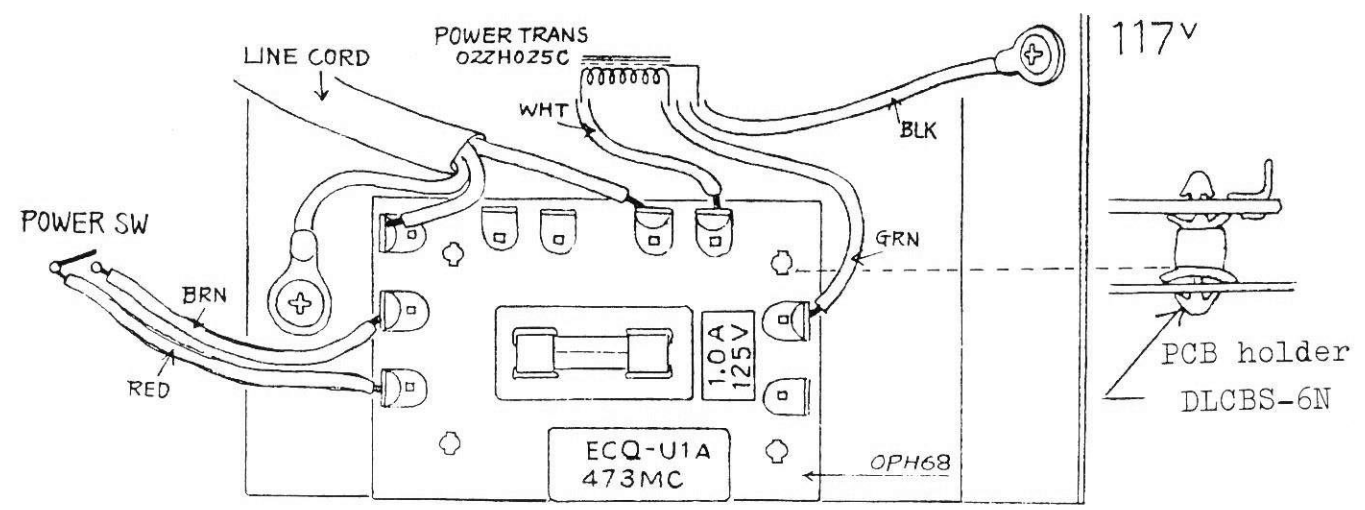
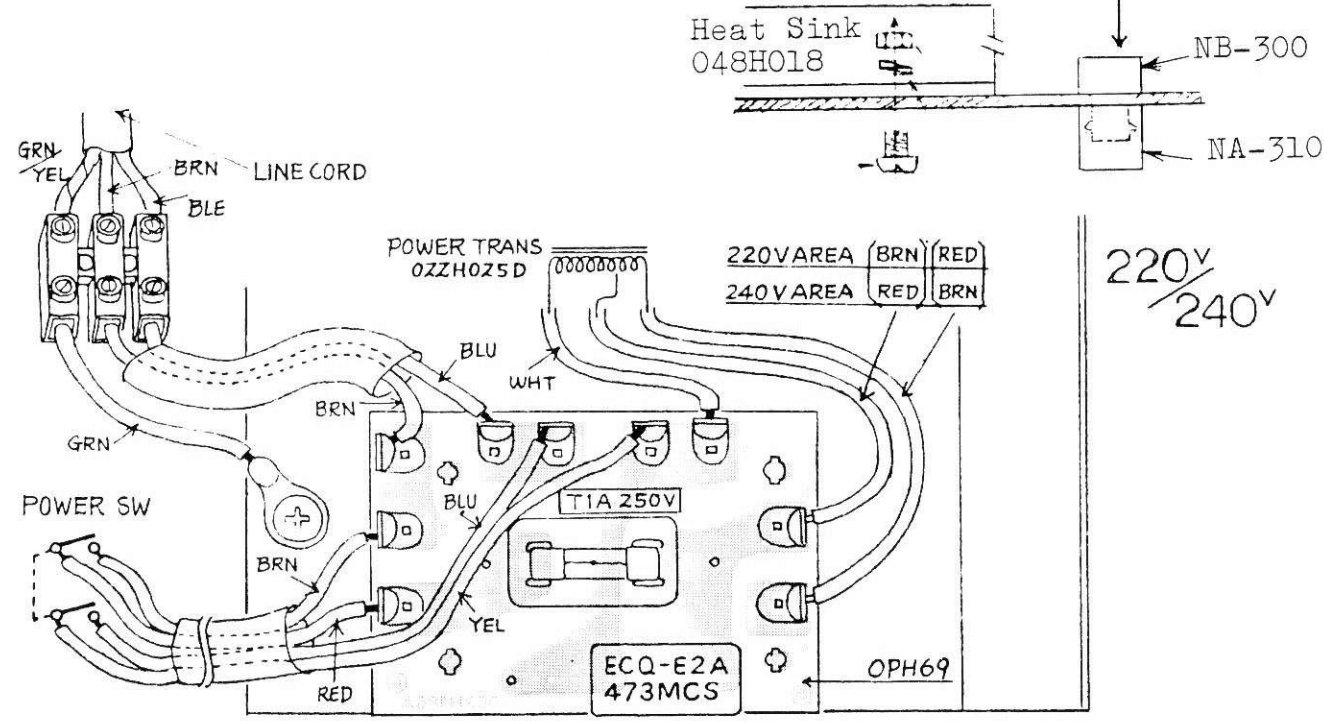
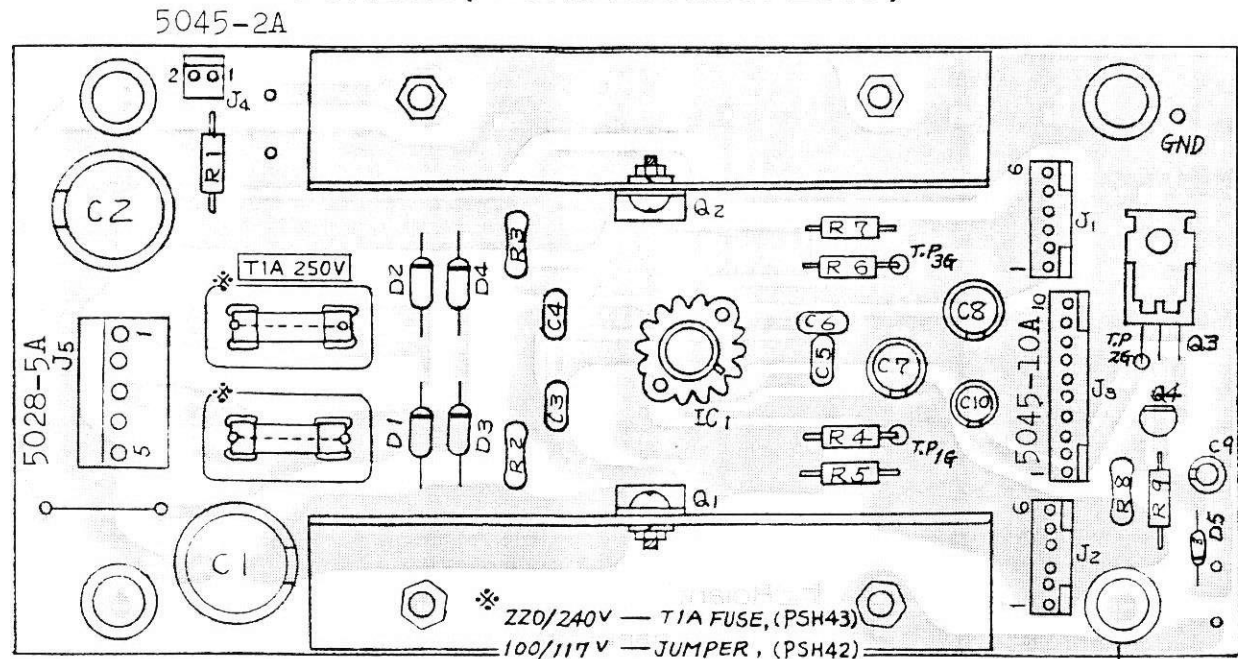

KEYBOARD PARTS

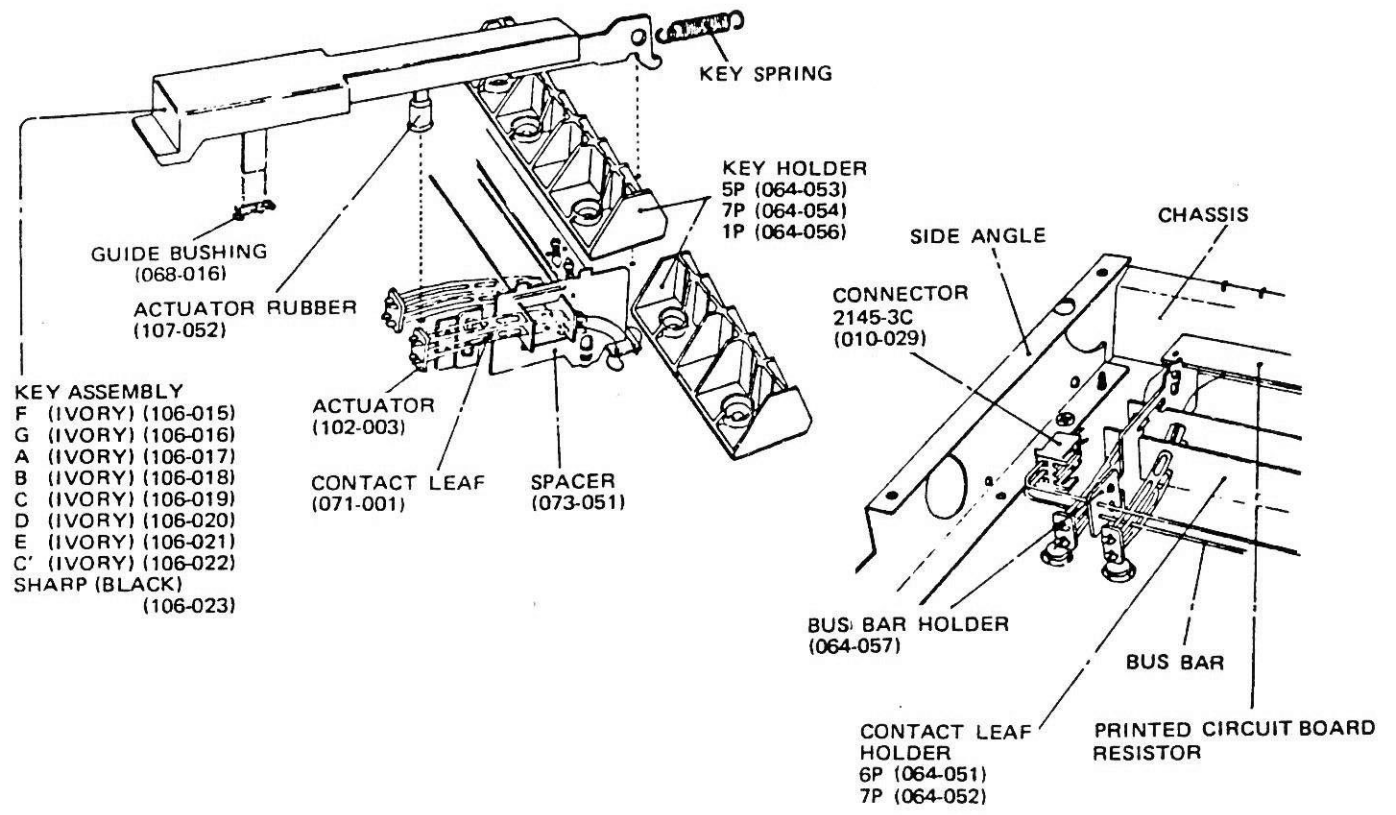

INSTRUMENT MODEL	NO. OF KEYS	KEYBOARD MODEL	KEY SPRING	BUS BAR	PCB		RESISTOR
					6P	7P	
SH-1	32	SK-132-D	070-052	071H034	052-066	052-067	100 1/4W $\pm 1\%$ CRB1/4FX
SH-3A	44	SK-142-A	070-052	071-008	052-066	052-067	100 1/4W $\pm 1\%$ CRB1/4FX
SH-5	44	SK-142-B	070-052	071-008	052-066	052-067	100 1/4W $\pm 1\%$ CRB1/4FX
SH-7	44	SK-142-C	070-052	071-008	052-066	052-067	100 1/4W $\pm 1\%$ CRB1/4FX
SH-1000	37	SK-132-A	070-052	071-006	052-066	052-067	1K 1/4W $\pm 2\%$
SH-2000	37	SK-132-B	070-052	071-006	052-066	052-067	1K 1/4W $\pm 2\%$ SELECTED
VP-330	49	SK191-B	070-058	071H043	052-081	052-082	
SYSTEM-100	37	SK-132-C	070-052	071-006	052-066	052-067	100 1/4W $\pm 1\%$ CRB1/4FX
SYSTEM-700	61	SK-162-C	070-058	071-007	052-066	052-067	100 1/4W $\pm 1\%$ CRA1/4FX
RS-101	61	SK-161-A	070-058	071-007	052-081	052-082	
RS-202	61	SK-161-A	070-058	071-007	052-081	052-082	
RS-505	49	SK-192-A	070-058	071H043	052-081	052-082	
EP-10	61	SK-162-A	070-058	071-007			
EP-20	61	SK-162-A	070-058	071-007			
EP-30	61	SK-162B	070-058	071-007	052-081	052-082	

PARTS LIST

NOTE:

Locally available parts and hardware are omitted, however, when need arises, the order sheet should include model, serial number and function as well as detail description for prompt dispatch.

081H207A Cabinet ass'y H207A
 059H008 Hinge H8
 111-021 Rubber foot G-5
 081H206 End block H206 left
 081H172 End block H172 right
 072H050A Panel H50A upper
 068-018 Bushing no.18 musick rack
 110H006 Rail H6 music rack
 072H051A Panel no.51A rear
 Keyboard SK-191B
 065H040 Blind H40
 016-026 Knob TK-113 large
 016-021 Knob TK-114 small
 016-033 Knob no.33 slide
 009-012 Jack SG-7622 PC mount
 009-036 Jack SG-7713 stereo
 010-264 Receptacle (femal) NC-3FP or D-3M
 022H025C Power transformer H25C 117V
 022H025D Power transformer H25D 220/240V
 022-129 Coil RC-855 180µH
 008-041 Fuse SGA-1A CSA 117V
 008-066 Fuse SEMKO T1A midget 220/240V

PCB ASSEMBLY
 144H017 AGH17 (PCB 052H187)
 149H056A HVH56A (PCB 052H188A)
 145H016A FLH16A (PCB 052H189A)
 151H009B ETH09B (PCB 052H190B)
 149H058 VBH58 (PCB 052H191)
 149H060 OPH60 (PCB 052H129-1)
 146H042A PSH42A 100/117V
 146H043A PSH43A 220/240V (PCB both 052H183A)
 149H059 JAH59 (PCB 052H196)
 149H068A OPH68A 117V
 149H069A OPH69A 220/240V (PCB both 052H185A)

For replacement, listed above will be supplied. Direct, or less-rewiring improved versions.

IC
 020-156 AY30214
 020-041 TC4013BP
 020-227 TC4520BP
 020-064 µPC4558C
 020-100 TL082CP
 020-160 BA662A
 020-228 TA7179M
 020-079 SAD1024A BBD
 020-162 SAD512D BBD
 020-219 CD4066BE

TRANSISTOR
 017-155 2SA1015-GR
 017-128 2SB596-Y
 017-130 2SC381-R
 017-129 2SC752G-0
 017-106 2SC1815-GR
 017-156 2SC1815-0
 017-090 2SD526-Y
 017-016 2SK30A-GR FET
 017-014 2SK30A-Y FET

DIODE
 018-086 SVC303 varicap
 018-014 1S2473
 018-114 1SR35-200 or 1N-4003
 019-028 TLR-124 LED red
 019-029 TLG-124 LED green
 POTENTIOMETER
 Slide
 029-447 LEF3R-C20A14 10kA
 029-459 LEF3R-C20B14 10kB
 029-450 LEF3R-C20A15 100kA
 029-453 LEF3R-C20A16 1MA
 029-472 LEF3R-C26B15L 100KB
 Rotary
 029-1050 VM60ZK30A14 10kA
 028-1058 VM60ZK30B24 20kB
 028-1059 VM60ZK30B54 50kB
 028-1054 VM60AK30A55 500kA
 028-670 GM70AK35B14 10kBx2 gang
 Trimmer
 030-459 SR19R 1k
 030-461 SR19R 2.2k
 030-467 SR19R 22k
 030-469 SR19R 47k
 030-471 SR19R 100k

SWITCH
 001-258 SDA1SA-1 100V power
 001-259 SDA2SA-1 117V power
 001-260 SDE4SA-1 220/220V power
 001-256 SLE643-15P lever 4p-3t
 001-297 HSW0372-1-020 slide
 002-004 SMT029A tablet STRINGS
 002-008 SMT039A tablet VOCODER
 002-009 SMT059A tablet HUMAN V.

TABLET
 003-010 Green 003-012 White
 003-011 Maroon 003-013 Gray
 Suffix legend when ordering.
 CAPACITOR
 035-129 50pfd 50V J styren
 035-156 150pfd 50V J styren
 032-275 4R7(4.7mfd) 25V K tantalum
 032-241 10mfd 16V electro.Non-polar
 Polypropylene film 2%
 035-343 ECQP1182GZ .0018mfd
 035-345 ECQP1272GZ .0027mfd
 035-346 ECQP1332GZ .0033mfd
 035-347 ECQP1392GZ .0039mfd
 035-349 ECQP1562GZ .0056mfd
 035-351 ECQP1822GZ .0082mfd
 035-353 ECQP1123GZ .012mfd
 035-354 ECQP1183GZ .018mfd
 035-355 ECQP1273GZ .027mfd
 035-357 ECQP1393GZ .039mfd
 035-358 ECQP1473GZ .047mfd
 035-359 ECQP1563GZ .056mfd
 RESISTOR
 CRB25FX
 Metal film ¼w 1%
 044-830 1k 044-849 180k
 044-862 1.2k 044-851 220k
 044-713 10k R-25G carbon ¼w 2%
 OTHERS
 048-084 Heatsink RH-15
 048H018 Heatsink No.18
 064H200 PCB holder DLC-BS-6N
 068-029 Collar bushing NA-310
 068-032 Collar bushing NA-305
 068-034 Collar bushing NB-300